

HL 94

***STIHL***



2 - 27      Instruction Manual



## Contents

1	Guide to Using this Manual.....	2
2	Safety Precautions and Working Techniques.....	2
3	Using the Unit.....	7
4	Approved Power Tool Attachments.....	10
5	Assembling the Unit.....	10
6	Fuel.....	11
7	Fueling.....	12
8	Adjusting the Cutter Bar.....	13
9	Fitting the Harness.....	14
10	Starting / Stopping the Engine.....	15
11	Operating Instructions.....	17
12	Cleaning the Air Filter.....	18
13	Adjusting the Carburetor.....	18
14	Spark Plug.....	18
15	Lubricating the Gearbox.....	19
16	Sharpening Instructions.....	20
17	Storing the Machine.....	21
18	Inspection and Maintenance by User.....	21
19	Inspections and Maintenance by Dealer.....	21
20	Maintenance and Care.....	22
21	Minimize Wear and Avoid Damage.....	23
22	Main Parts.....	24
23	Specifications.....	24
24	Maintenance and Repairs.....	26
25	Disposal.....	26
26	EC Declaration of Conformity.....	26
27	UKCA Declaration of Conformity.....	27
28	Addresses.....	27

## 1 Guide to Using this Manual

### 1.1 Pictograms

The meanings of the pictograms attached to the machine are explained in this manual.

Depending on the model concerned, the following pictograms may be attached to your machine.



Fuel tank; fuel mixture of gasoline and engine oil



Operate manual fuel pump



Filler hole for gear lubricant

## 1.2 Symbols in text



**WARNING**

Warning where there is a risk of an accident or personal injury or serious damage to property.

*NOTICE*

Caution where there is a risk of damaging the machine or its individual components.

## 1.3 Engineering improvements

STIHL's philosophy is to continually improve all of its products. For this reason we may modify the design, engineering and appearance of our products periodically.

Therefore, some changes, modifications and improvements may not be covered in this manual.

## 2 Safety Precautions and Working Techniques



Because a long-reach hedge trimmer is a high-speed, fast-cutting power tool with very sharp cutting blades and a long reach, special safety precautions must be observed during operation.



It is important that you read and understand the User Manual before commissioning and keep it in a safe place for future reference. Non-compliance with the User Manual may cause serious or even fatal injury.

Observe all applicable local safety regulations, e.g. by trade organizations, social insurance institutions, labor safety authorities etc.

If you have never used a power tool before: Have your dealer or other experienced user show you how to operate your machine – or attend a special course to learn how to operate it.

Minors are not allowed to work with the power tool – except adolescents above 16 years of age who are instructed under supervision.

Children, animals and onlookers must not be allowed near the machine.

When not using the machine, it must be laid down in such a way that it does not endanger anyone. Ensure that the machine cannot be used without authorization.

The user is responsible for accidents or risks involving third parties or their property.

Lend or rent your power tool only together with this User Manual and only to persons who are familiar with this model and its operation.

The use of machines that emit noise may be limited to certain hours of the day as specified by national and/or regional or local regulations.

Anyone operating the machine must be well rested, in good physical health and in good mental condition.

If you have any condition that might be aggravated by strenuous work, check with your doctor before operating a machine.

If you have a pacemaker: The ignition system of your machine produces an electromagnetic field of very low intensity. This field may interfere with some pacemakers. STIHL recommends that persons with pacemakers consult their physician and the pacemaker manufacturer to reduce any health risk.

Anyone who has consumed alcohol or drugs or medicines affecting their ability to react must not operate a power tool.

Use the machine only for cutting hedges, shrubs, bushes, scrub and the like.

Other uses are not permitted and may lead to accidents or damage to the machine. Never attempt to modify your power tool in any way since this may result in accidents or damage to the machine.

Only use cutting blades and accessories that are explicitly approved for this power tool by STIHL or are technically identical. If you have any questions in this respect, consult your dealer. Use only high-quality parts and accessories. In order to avoid the risk of accidents and damage to the machine.

STIHL recommends the use of genuine STIHL tools and accessories. They are specifically designed to match the product and meet your performance requirements.

Never attempt to modify your power tool in any way since this may increase the risk of personal injury. STIHL excludes all liability for personal injury and damage to property caused while using unauthorized attachments.

Do not use a high-pressure washer to clean the power tool. The solid jet of water may damage parts of the unit.

Do not spray the machine with water.

## 2.1 Clothing and equipment

Wear proper protective clothing and equipment.



Clothing must be robust but allow complete freedom of movement. Wear close-fitting clothes such as a boiler suit, not a loose jacket.



Do not wear clothing which could become trapped in wood, brush or moving parts of the machine. Do not wear a scarf, necktie or jewelry. Tie up and confine long hair above your shoulders.



Wear safety boots with steel toe caps and non-slip soles.



### WARNING



To reduce the risk of eye injuries, wear close-fitting safety glasses in accordance with European Standard EN 166. Make sure the safety glasses are a snug fit.

Wear "personal" sound protection, e.g. ear defenders.

Wear a safety hard hat where there is a danger of head injuries from falling objects.



Wear sturdy protective gloves made of a resistant material (e. g. leather).

STIHL can supply a comprehensive range of personal protective equipment.

## 2.2 Transporting the machine

Always stop the engine.

Always fit the scabbard over the blades before transporting the machine even for short distances.

For machines with a defined transport position: Move the cutter bar into transport position and have it engaged.

Carry the power tool properly balanced by the shaft – cutting blades behind you.

Avoid touching hot parts of the machine and gear housing – **risk of burns!**

By vehicle: When transporting in a vehicle, properly secure your machine to prevent turnover, damage and fuel spillage.

## 2.3 Refueling



**Gasoline is highly flammable** – keep away from fire or flame – do not spill any fuel – no smoking.

Always **shut off the engine** before refueling.

Do not fuel a hot engine – **fuel may spill and cause a fire.**

Open the fuel cap carefully to allow any pressure build-up in the tank to release slowly and avoid fuel spillage.

Only refuel the machine in a well ventilated place. If fuel has been spilled, immediately clean the machine – do not allow your clothes to be splashed with fuel. If that happens, change your clothes at once.



After refueling, close the fuel cap as tightly as possible.

This helps reduce the risk of unit vibrations causing an incorrectly tightened fuel cap to loosen or come off and spill quantities of fuel.

Check for leaks. Do not start the engine if there is a fuel leak – **serious or fatal burns could result!**

## 2.4 Before starting

Check that your power tool is properly assembled and in good condition – refer to appropriate chapters in the User Manual:

- Check the fuel system for leaks, especially the visible parts, e. g., fuel cap, hose connections, manual fuel pump (only in machines with a manual fuel pump). In case of leakage and damage, do not start the engine – **risk of fire!** Have the machine serviced by a dealer before using it
- The stop switch must be easy to push
- Check the rotary knob for warm start, throttle trigger lockout, throttle trigger and set wheel for smooth action – the throttle trigger must return automatically to idle position. From the warm start knob position **I**, it must return to the run position **I** when the throttle trigger lockout and throttle trigger are pressed simultaneously
- Check that the spark plug boot is secure – a loose boot may cause sparking that could ignite combustible fumes **and cause a fire!**
- Cutting blades must be properly tightened and in safe operating condition (clean, sharp, not bent or warped), correctly mounted and thor-

oughly sprayed with STIHL resin solvent (lubricant)

- For machines with adjustable cutter bar: The adjustment mechanism must be snapped into the start position
- For machines with a defined transport position (cutter bar folded against the shaft): Never start the machine in the transport position
- Never attempt to modify the controls or safety devices.
- Keep the handles dry and clean – free from oil and dirt – this is important for safe control of the machine
- Adjust carrying harness and handles in accordance with body height. Observe the chapter "Fitting the Harness"

**To reduce the risk of personal injury**, do not operate your power tool if it is damaged or not properly assembled!

To prepare for emergencies when using a harness: Practice setting down the machine quickly. To avoid damage, do not throw the machine to the ground when practicing.

## 2.5 Starting the engine

Start the engine at least 3 meters from the fueling spot, outdoors only.

Place the power tool on firm ground in an open area. Make sure you have good balance and secure footing. Hold the power tool securely. The cutting blades must be clear of the ground and all other obstructions because they may begin to run when the engine starts.

Your power tool is designed to be operated by one person only. Do not allow other persons in the work area – even when starting.

Avoid contact with the cutting blades – **risk of injury!**

Do not drop-start the engine – start it as described in the User Manual. Note that the cutting blades continue to run for a short period after you let go of the throttle trigger (flywheel effect).

Check engine idling: The cutting blades must remain at a standstill when the engine idles – throttle trigger released.

Keep easily combustible materials (e.g., wood chips, bark, dry grass, fuel) away from hot exhaust gases and the hot muffler surface – **risk of fire!**

## 2.6 Holding and guiding the machine

Always hold the unit firmly with both hands on the handles.

Make sure you always have a secure footing and hold the machine so that the cutting blades are always facing away from your body.

Some versions of the machine can be carried on a harness to relieve the weight on the operator's arms.

### 2.6.1 Models with Loop Handle

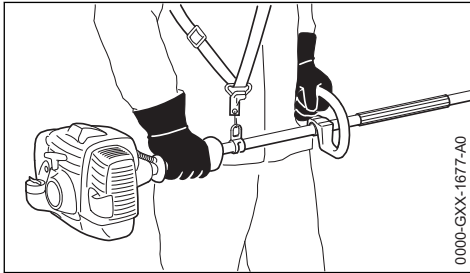

Keep your right hand on the control handle and your left hand on the loop handle on the shaft – this applies to left-handed people as well. Wrap your fingers and thumbs around the handles.

### 2.6.2 Machines with handle hose

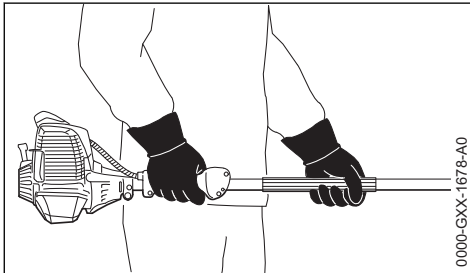

Right hand on control handle, left hand on handle hose on drive tube, even if you are left-handed. Wrap your fingers and thumbs around the handles.

## 2.7 While working

In the event of impending danger or in an emergency, switch off the engine immediately – push the stop switch.



This power tool is not insulated. Keep away from power cables – **danger of electrocution!**



To reduce the risk of injury from moving blades or falling cuttings, do not allow bystanders within 5 meters of your own position.

This distance must also be maintained in relation to objects (vehicles, window panes) – **risk of property damage!**

Watch the cutting blades at all times – do not cut areas of the hedge that you cannot see.

Be extremely careful when cutting tall hedges; check the other side of the hedge before starting work.

Check for correct idling, so that the cutting blades stop moving when the throttle trigger is released. Check and correct the idle speed setting at regular intervals. If the cutting blades still run, have your dealer check your machine and make proper adjustments or repairs.

Note that the cutting blades continue to run for a short period after you let go of the throttle trigger – **flywheel effect!**

Take special care in slippery conditions – **damp, snow, ice**, on slopes or uneven ground.

Clear away fallen branches, scrub and cuttings.

Watch out for obstacles: tree stumps, roots – **risk of tripping or stumbling!**

Make sure you always have a firm and secure footing.

### 2.7.1 When working at heights:

- Always use a lift bucket
- Never use the machine while standing on a ladder or in a tree
- never work on an unstable surface
- Never use the machine with just one hand

Be particularly alert and cautious when wearing hearing protection because your ability to hear warnings (shouts, alarms, etc.) is restricted.

Take breaks when you start getting tired or feeling fatigue – **risk of accidents!**

Work calmly and carefully – in daylight conditions and only when visibility is good. Proceed with caution, do not put others in danger.



Your power tool produces toxic exhaust fumes as soon as the engine starts running. These gases may be odorless and invisible and may contain unburned hydrocarbons and benzene. Never run the engine indoors or in poorly ventilated locations, even if your model is equipped with a catalytic converter.

To reduce the risk of **serious or fatal injury from breathing toxic fumes**, ensure proper ventilation when working in trenches, hollows or other confined locations.

Stop work immediately if you start suffering from nausea, headaches, impaired vision (e.g. your field of vision gets smaller), impaired hearing, dizziness, or impaired concentration – these symptoms may possibly be the result of too-high exhaust gas concentration – **Risk of accidents!**

Operate your power tool so that it produces a minimum of noise and emissions – do not run the engine unnecessarily, accelerate the engine only when working.

To reduce the risk of fire, **do not smoke** while operating or standing near your power tool. Combustible fuel vapor may escape from the fuel system.

Dusts, mist and fumes emissions during the work may be hazardous to your health. Wear respiratory protection in case of heavy dust or smoke emission.



The gear head becomes hot during operation. **To reduce the risk of burn injury**, do not touch the gear housing!

If your power tool is subjected to unusually high loads for which it was not designed (e.g. heavy impact or a fall), always check that it is in good condition before continuing work – see also "Before Starting". Check in particular that the fuel system has no leaks and the safety equipment is fully operative. Never use a power tool that is no longer safe to operate. In case of doubt, contact a dealer.

Do not operate your power tool in the starting throttle position – engine speed cannot be controlled in this position.

Inspect the hedge and work area to avoid damaging the cutting blades:

- Remove stones, rocks, pieces of metal and other solid objects
- When working close to the ground, make sure that no sand, grit or stones get between the cutting blades
- Take particular care when cutting hedges next to or against wire fences

Do not touch electric power lines – never cut through electric power lines – **risk of electrocution!**



Do not touch the cutting blades while the engine is running. If the cutting blades become jammed by an object, switch off the engine immediately before attempting to remove the object – **risk of injury!**

Opening the throttle when the cutting blades are jammed increases the load and reduces the working speed of the engine. The constant slipping of the clutch causes overheating and damage to important components (e.g. coupling, plastic housing parts) – thus e.g. due to the cutting blade moving during idling – **risk of injury!**

If the hedge is very dusty or dirty, spray the cutting blades with STIHL resin solvent from time to time during cutting. This helps reduce blade friction as well as the aggressive effects of sap and the build-up of dirt particles.

Before you leave the machine: Shut the engine off.

Check the cutting blades at regular, frequent intervals during operation or immediately if there is a noticeable change in cutting behavior:

- Shut off the engine
- Wait for cutting blades to come to a standstill
- Check condition and tightness of connections, look out for fine cracks
- Ensure that the cutting blades are sharp

Always clean plant residue, chips, leaves and excess lubricant off the engine and muffler – **risk of fire!**

## 2.8 After finishing work

Always clean dust and dirt off the machine – do not use any grease solvents for this purpose.

Spray the cutting blades with STIHL resin solvent. Run the motor briefly so that the solvent is evenly distributed.

## 2.9 Vibrations

Prolonged use of the power tool may result in vibration-induced circulation problems in the hands (whitefinger disease).

No general recommendation can be given for the length of usage because it depends on several factors.

The period of usage is prolonged by:

- Hand protection (wearing warm gloves)
- Work breaks

The period of usage is shortened by:

- Any personal tendency to suffer from poor circulation (symptoms: frequently cold fingers, tingling sensations).
- Low outside temperatures.
- The force with which the handles are held (a tight grip restricts circulation).

Continual and regular users should monitor closely the condition of their hands and fingers. If any of the above symptoms appear (e.g. tingling sensation in fingers), seek medical advice.

## 2.10 Maintenance and Repairs

Service the machine regularly. Do not attempt any maintenance or repair work not described in the instruction manual. Have all other work performed by a servicing dealer.

STIHL recommends that you have servicing and repair work carried out exclusively by an authorized STIHL servicing dealer. STIHL dealers are regularly given the opportunity to attend training courses and are supplied with the necessary technical information.

Only use high-quality replacement parts in order to avoid the risk of accidents and damage to the power tool. If you have any questions in this respect, consult a servicing dealer.

STIHL recommends the use of original STIHL replacement parts. They are specifically designed to match your model and meet your performance requirements.

To reduce the risk of injury, **always shut off the engine** before carrying out any maintenance or repairs or cleaning the machine. – Exception: Carburetor and idle speed adjustments.

Do not turn the engine over on the starter with the spark plug boot or spark plug removed since there is otherwise a **risk of fire** from uncontained sparking.

To reduce the **risk of fire**, do not service or store your machine near open flames.

Check the fuel filler cap for leaks at regular intervals.

Use only a spark plug of the type approved by STIHL and make sure it is in good condition – see "Specifications".

Inspect the ignition lead (insulation in good condition, secure connection).

Check the condition of the muffler.

**To reduce the risk of fire and damage to hearing**, do not operate your machine if the muffler is damaged or missing.

Do not touch a hot muffler since **burn injury** will result.

Vibration behavior is influenced by the condition of the AV elements – check the AV elements at regular intervals.

## 3 Using the Unit

### 3.1 Cutting Season

Observe country-specific or municipal rules and regulations for cutting hedges.

Do not use your hedge trimmer during rest periods customary in the neighborhood.

### 3.2 Cutting Sequence

If a radical cut is necessary, cut a little at a time in several stages.

Use lopping shears to cut out thick branches first.

Cut the sides of the hedge first, then the top.

### 3.3 Disposal

Do not throw cuttings into the garbage can – they can be composted.

### 3.4 Preparations

- ▶ Model with adjustable cutter bar: Set the cutter bar to the straight (0°) position.
- ▶ Remove the blade scabbard.
- ▶ Start the engine.
- ▶ If you use a harness: Put on the harness and attach it to the machine.

## 3.5 Working Techniques

### 3.5.1 Horizontal Cut (with cutter bar at an angle)



Cutting close to the ground from a standing position, e.g. low shrubs.

Swing the cutter bar from side to side as you move along – use both sides of the cutting blades, do not rest the cutter bar on the ground.

### WARNING

K versions (HL 92 K, HL 94 K) are not approved for cutting close to the ground.

### 3.5.2 Vertical Cut (with cutter bar at an angle)



Cutting without standing directly next to the hedge, e.g. flowerbed between operator and hedge.

Swing the cutter bar up and down in an arc as you move along the hedge – use both sides of the cutting blades.



### 3.5.3 Vertical Cut (with straight cutter bar)

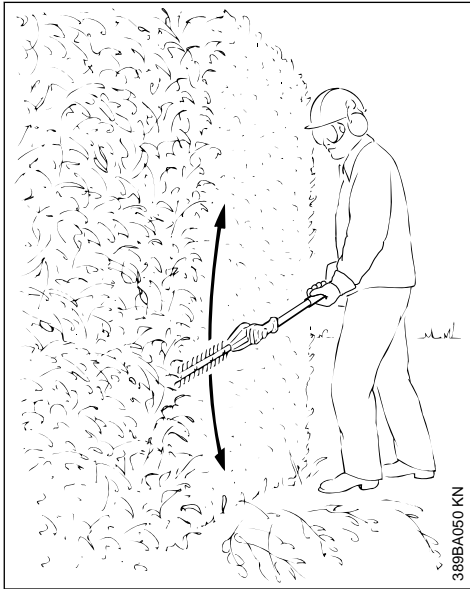

Extra long reach without the need for other aids.

Swing the cutter bar up and down in an arc as you move along the hedge – use both sides of the cutting blades.

### 3.5.4 Overhead Cut (with cutter bar at an angle)

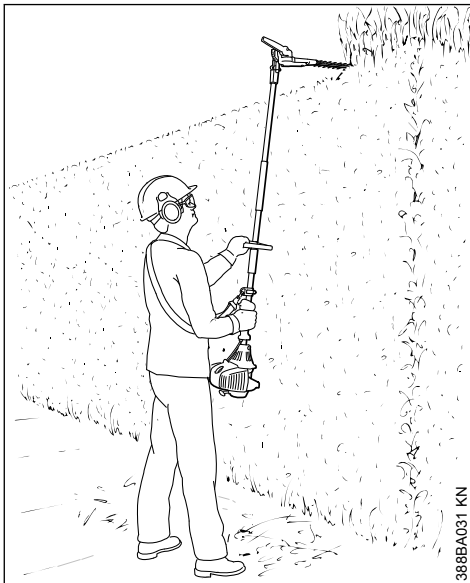

Hold the hedge trimmer vertically and swing it in an arc to make maximum use of its reach.

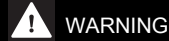

**WARNING**

Any working position above head height is tiring. To minimize the risk of accidents, work in such positions for short periods only. Set the adjustable cutter bar to the most suitable angle so that the trimmer can be held in a lower, less tiring position while still providing adequate reach.

### 3.5.5 Horizontal Cut (with straight cutter bar)

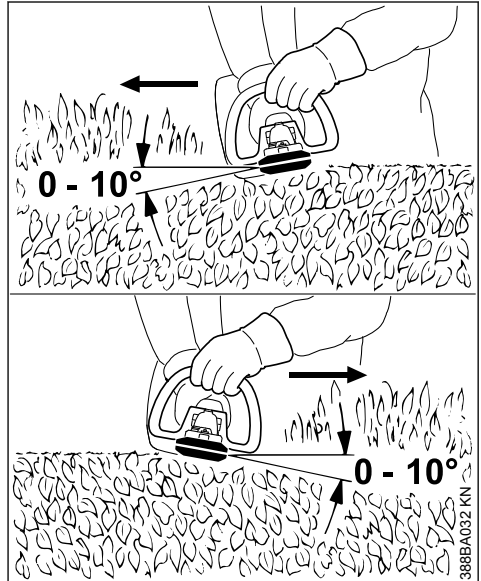

Hold the cutter bar at an angle of  $0^{\circ}$  to  $10^{\circ}$  as you swing the hedge trimmer horizontally.

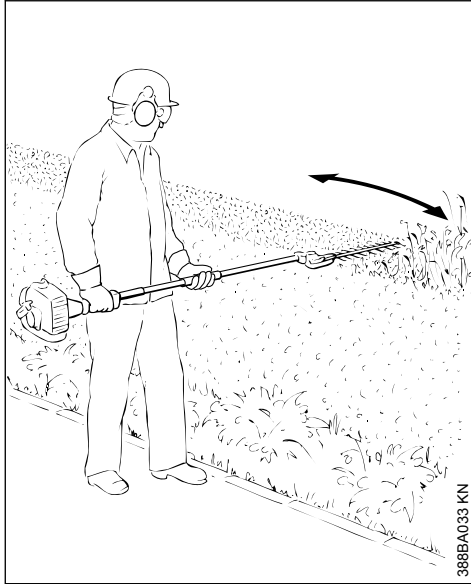

Swing the cutter bar in an arc towards the outside of the hedge so that the cuttings are swept to the ground.

Recommendation: Only cut hedges that are no more than chest high.

## 4 Approved Power Tool Attachments

The following STIHL attachments may be used with the basic power tool:

Attachment	Application
HL 0°, 500 mm <sup>1)</sup>	Long reach hedge trimmer
HL 0°, 600 mm <sup>1)</sup>	Long reach hedge trimmer
HL 145°, 500 mm <sup>1)</sup>	Long reach hedge trimmer
HL 145°, 600 mm <sup>1)</sup>	Long reach hedge trimmer
HT <sup>2)</sup>	Pole pruner
BF <sup>2) 3)</sup>	Cultivator with pick tines
SP 10	Special harvester

<sup>1)</sup> Loop handle required on versions with long drive tube (HL 92, HL 94)

<sup>2)</sup> Must not be mounted to versions with short drive tube (HL 92 K, HL 94 K)

<sup>3)</sup> Loop handle required

## 5 Assembling the Unit

### 5.1 Mounting the Loop Handle (HL 92, HL 94)

Loop handle is required on versions with long drive tube (HL 92, HL 94).

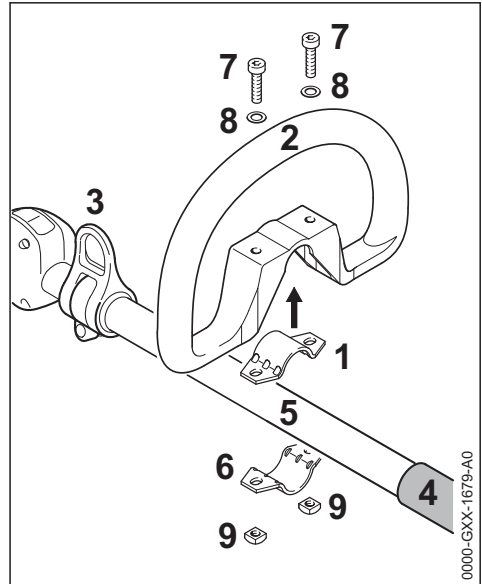

- ▶ Place the clamp (1) in the loop handle (2) and position them both against the drive tube (5) between the carrying ring (3) and handle hose (4).
- ▶ Position the clamp (6) against the shaft.
- ▶ Line up the holes.
- ▶ Insert the screws (7) with washers (8).
- ▶ Fit the square nuts (9) and screws.

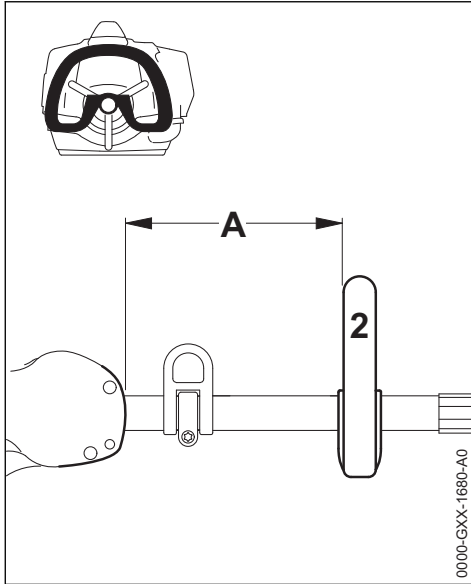

- ▶ Align the loop handle (2) and move it to the most comfortable position (recommended: about 20 cm).
- ▶ Tighten down the screws firmly.

## 5.2 Mounting the Gearbox

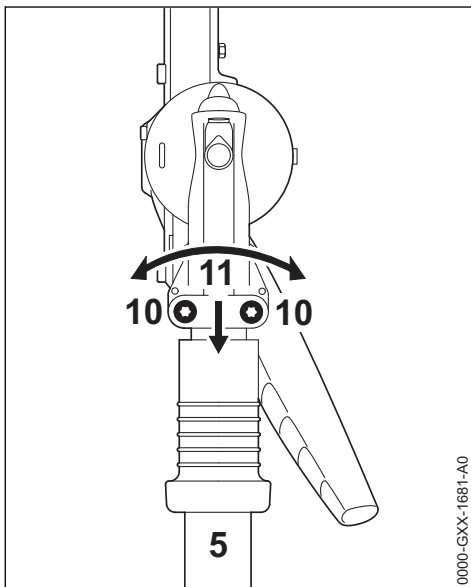

- ▶ Loosen the clamp screws (10).

- ▶ Push the gearbox (11) onto the drive tube (5), turn the gearbox (11) back and forth as necessary.

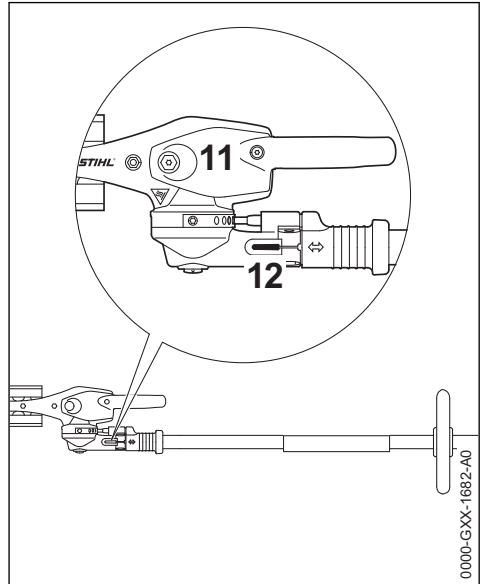

Once the end of the drive tube is inserted beyond the slot in the clamp (12):

- ▶ Push the gearbox (11) fully home as far as stop.
- ▶ Tighten down the clamp screws moderately.
- ▶ Line up the gearbox (11) with the powerhead.
- ▶ Tighten down the clamp screws firmly.

## 6 Fuel

The engine requires a mixture of gasoline and engine oil.



**WARNING**

Avoid direct skin contact with fuel and breathing in of gasoline fumes.

### 6.1 STIHL MotoMix

STIHL recommends using STIHL MotoMix. This pre-blended fuel is free of benzene and lead, is distinguished by a high octane rating, and always provides the proper mixing ratio.

STIHL MotoMix uses STIHL HP Ultra two-stroke engine oil for optimum engine life.

MotoMix is not available in all markets.

## 6.2 Mixing fuel

### NOTICE

Unsuitable fuels or a mixing ratio that deviates from the specification can lead to severe engine damage. The engine, seals, fuel lines and fuel tank may be damaged if low-quality gasoline or engine oil is used.

### 6.2.1 Gasoline

Use only **high-quality gasoline** with an octane rating of at least 90 ROC – leaded or unleaded.

Gasoline with an alcohol component exceeding 10% can cause impaired engine performance in engines with manually adjustable carburetors and thus should not be used in these engines.

Engines with M-Tronic deliver full engine performance using gasoline with an alcohol component of up to 27% (E27).

### 6.2.2 Engine oil

If you mix the fuel yourself, use only STIHL two-stroke engine oil or another high-performance engine oil classified as JASO FB, JASO FC, JASO FD, ISO-L-EGB, ISO-L-EGC or ISO-L-EGD.

STIHL specifies STIHL HP Ultra two-stroke engine oil or an equivalent high-performance engine oil in order to maintain emission limits over the machine's service life.

### 6.2.3 Mixing ratio

with STIHL two-stroke engine oil 1:50; 1:50 = 1 part oil + 50 parts gasoline

### 6.2.4 Examples

Quantity of gasoline	STIHL two-stroke engine oil 1:50
Liters	Liters (ml)
1	0.02 (20)
5	0.10 (100)
10	0.20 (200)
15	0.30 (300)
20	0.40 (400)
25	0.50 (500)

- Pour oil into an approved safety fuel canister first, then add gasoline and mix thoroughly

## 6.3 Storing fuel mixture

Store in approved safety fuel canisters only in a dry, cool and secure place protected against light and sunlight.

**Fuel mixture deteriorates with age** – mix only as much as needed for a few weeks. Do not store fuel mixture for longer than 30 days. The fuel mixture can become unusable more quickly if exposed to light, sunlight or low or high temperatures.

STIHL MotoMix however can be stored for up to 5 years without any problems.

- Shake the canister containing the fuel mixture thoroughly before refueling



### WARNING

Pressure may have built up in the canister – open it carefully.

- The fuel tank and the canister in which fuel mixture is stored should be cleaned thoroughly from time to time

Residual fuel and the liquid used for cleaning must be disposed of in accordance with regulations and without harming the environment!

## 7 Fueling

### 7.1 Fuel filler cap

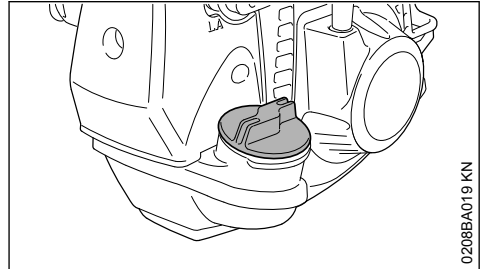

0208BA019 KN



### WARNING

When fueling on a slope, always position the machine with the filler cap facing uphill.

- Place the machine on level ground so that the filler cap is facing up.
- Before fueling, clean the filler cap and the area around it to ensure that no dirt falls into the tank.

## 7.2 Open the tank cap.

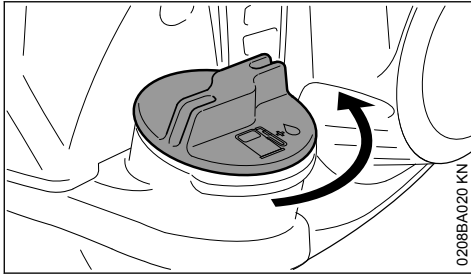

- ▶ Turn the cap counterclockwise until it can be removed from the tank opening.
- ▶ Remove the cap.

## 7.3 Filling up with fuel

Take care not to spill fuel while fueling and do not overfill the tank.

STIHL recommends you use the STIHL filler nozzle for fuel (special accessory).

- ▶ Fill up with fuel.

## 7.4 Close the tank cap.

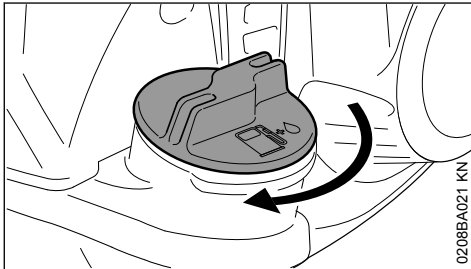

- ▶ Place the cap in the opening.
- ▶ Turn the cap clockwise as far as stop and tighten it down as firmly as possible by hand.

# 8 Adjusting the Cutter Bar

## 8.1 Angle Adjuster - 145°

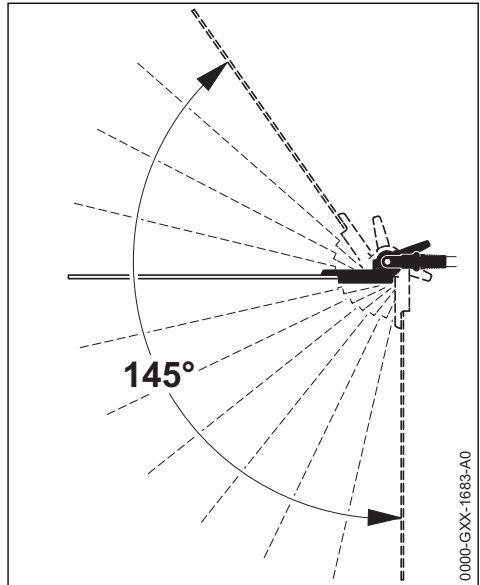

The angle of the cutter bar can be adjusted upwards in 4 stages from 0° (straight) to 55°, and downwards in 7 stages from 0° to 90° (right angle facing down). There are therefore 12 possible working positions.

### ! WARNING

**To reduce the risk of injury**, carry out the adjustment only when the cutting blades are at a standstill – engine at idle speed.

### ! WARNING

The gearbox gets hot during operation. **To reduce the risk of burn injury**, do not touch the gearbox.

### ! WARNING

**To reduce the risk of injury**, never touch the blades while making adjustments.

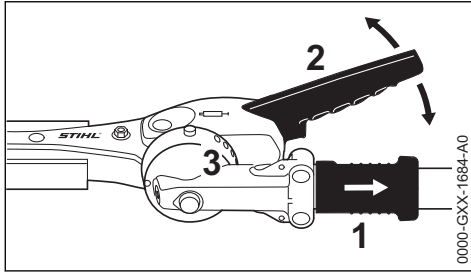

- ▶ Pull back the sliding sleeve (1) and use the lever (2) to adjust the joint by one or several holes.
- ▶ Release the sliding sleeve (1) and make sure the lock pin engages the quadrant (3).

## 8.2 Transport Position

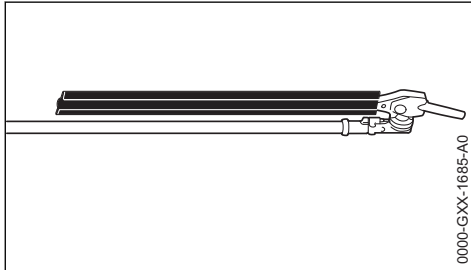

The cutter bar can be folded flat against the drive tube and locked in position to save space during transportation.

### **!** WARNING

**To reduce the risk of injury**, always shut off the engine – depress stop switch – and fit the blade scabbard before moving the cutter bar to the transport position or from the transport position to the normal working position.

### **!** WARNING

The gearbox gets hot during operation. **To reduce the risk of burn injury**, do not touch the gearbox.

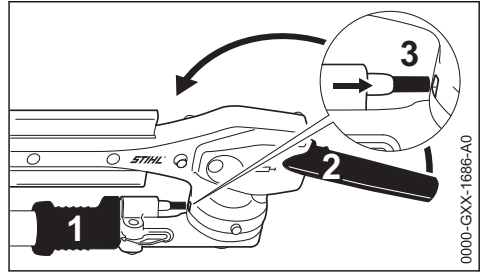

- ▶ Shut off the engine.
- ▶ Fit the blade scabbard.
- ▶ Pull back the sliding sleeve (1) and use the lever (2) to swing the joint upwards – in direction of drive tube – until the cutter bar is flat against the drive tube.
- ▶ Release the sliding sleeve (1) and make sure the lock pin engages the quadrant (3).

## 9 Fitting the Harness

Some versions of the machine can be carried on a shoulder strap.

The type and style of the shoulder strap depend on the market.

### 9.1 Shoulder Strap

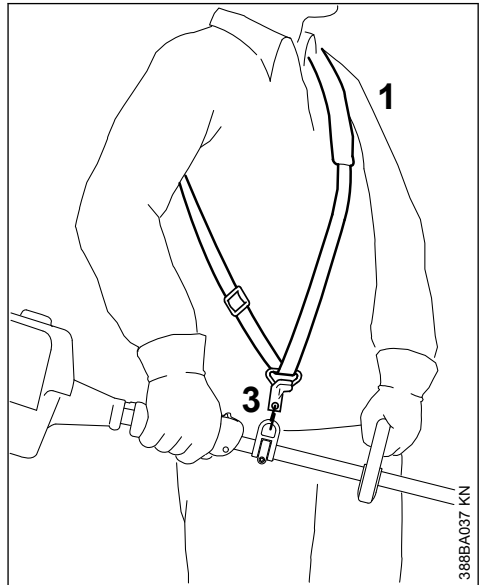

- ▶ Put on the shoulder strap (1).
- ▶ Adjust the length of the strap.

- ▶ With the power tool attached, the carabiner (3) must be at about the same height as your right hip.

## 9.2 Attaching Machine to Shoulder Strap

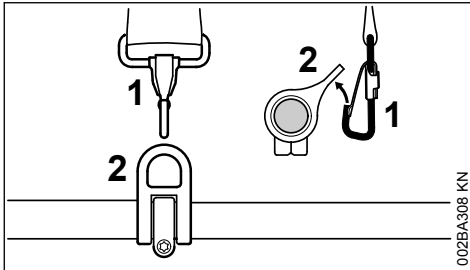

- ▶ Attach the carabiner (1) to the carrying ring (2) on the drive tube – hold the carrying ring steady.

## 9.3 Disconnecting Machine from Shoulder Strap

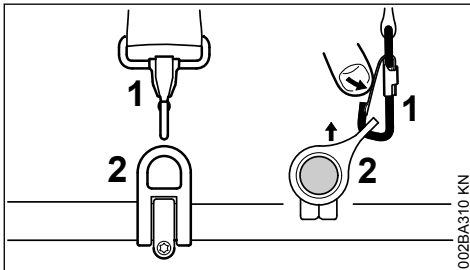

- ▶ Press down the bar on the carabiner (1) and pull the carrying ring (2) out of the carabiner.

## 9.4 Throwing Off the Machine

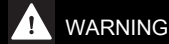

The machine must be quickly thrown off in the event of imminent danger. Practice removing and putting down the machine as you would in an emergency. To avoid damage, do not throw the machine to the ground when practicing.

Practice quickly detaching the power tool from the carabiner as described under "Disconnecting Machine from Shoulder Strap".

If you are using a shoulder strap: Practice slipping the strap off your shoulder.

## 10 Starting / Stopping the Engine

### 10.1 Controls

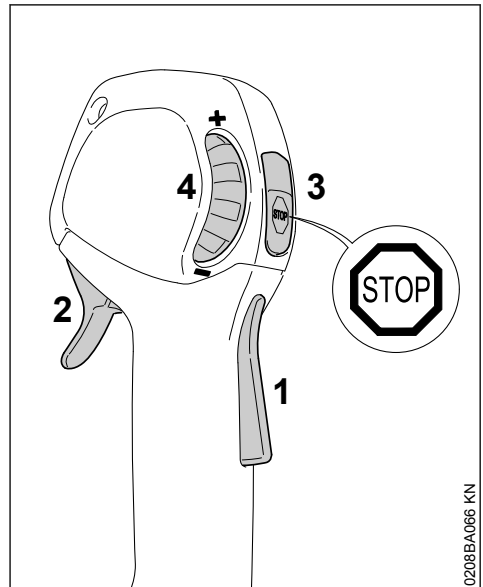

- 1 Throttle trigger lockout
- 2 Throttle trigger
- 3 Stop switch with Run and Stop positions. Depress the stop switch (⊖) to switch off the ignition – see "Function of Stop Switch and Ignition System".
- 4 Throttle set wheel – limits travel of throttle trigger – see "Function of Throttle Set Wheel".

### 10.1.1 Function of Stop Switch and Ignition System

The ignition is switched off and the engine stopped when the stop switch is pressed. The stop switch returns automatically to the **Run** position when it is released: The ignition is switched on again after the engine stops – the engine is then ready to start.

### 10.1.2 Function of Throttle Set Wheel

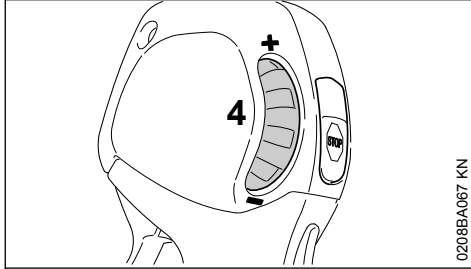

The throttle set wheel (4) enables the travel of the throttle trigger to be preset anywhere between idle and full throttle.

- Turn throttle set wheel (4) in direction of – to reduce throttle trigger travel and maximum engine speed.
- Turn throttle set wheel (4) in direction of + to increase throttle trigger travel and maximum engine speed.
- It is possible to override the preset stop and open the throttle wide by pulling the throttle trigger firmly – the preset stop remains unaffected. The original setting is restored when the throttle trigger is released.

## 10.2 Starting the Engine

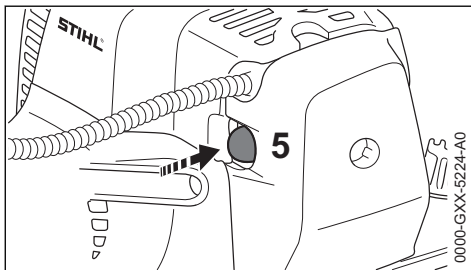

- ▶ Press the manual fuel pump bulb (5) at least five times – even if the bulb is already filled with fuel.

### Cold engine (cold start)

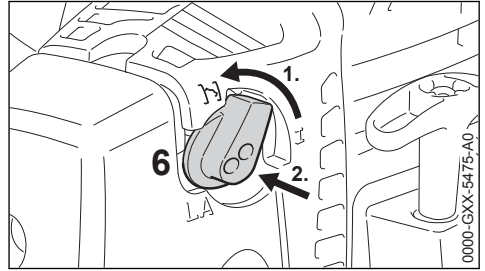

- ▶ Turn choke knob (6) and then push it in at 

Also use this setting if the engine has been running but is still cold.

- Turn throttle set wheel in direction of + as far as stop.

### Hot engine (hot start)

- ▶ Choke knob (6) remains in I position.

### 10.2.1 Cranking

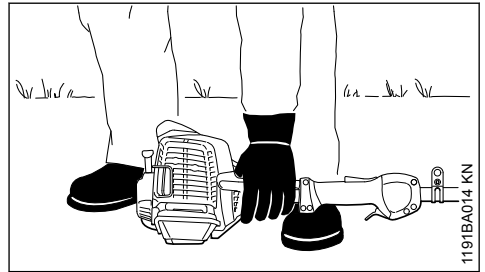

- ▶ Place the machine on the ground: It must rest securely on the engine support and the gearbox housing.
- ▶ On units with an adjustable cutter bar and defined transport position: Set the cutter bar to the straight (0°) position.
- ▶ If fitted: Remove blade scabbard from the cutting blades.

**To reduce the risk of accidents**, check that the cutting blades are not touching the ground of any other obstacles.

- ▶ Make sure you have a firm footing, either standing, stooping or kneeling.
- ▶ Hold the machine **firmly** on the ground with your left hand and press down – do not touch the throttle trigger, lockout lever or stop switch.



**NOTICE**

Do not stand or kneel on the shaft.

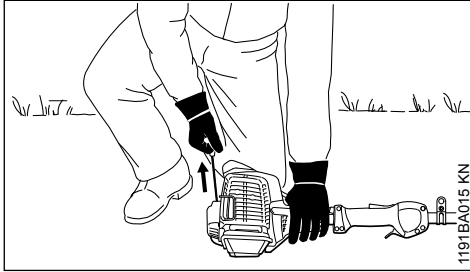

- ▶ Hold the starter grip with your right hand.

**10.2.2 Version without ErgoStart**

- ▶ Pull the starter grip slowly until you feel it engage and then give it a brisk strong pull.

**10.2.3 Version with ErgoStart (C-E)**

- ▶ Pull the starter rope slowly and steadily.

**NOTICE**

Do not pull out the starter rope all the way – it might otherwise break.

- ▶ Do not let the starter grip snap back. Guide it slowly back into the housing so that the starter rope can rewind properly.
- ▶ Continue cranking until the engine runs.

**10.2.4 As soon as the engine runs****At temperatures below +10°C**

Warm up the engine for at least 10 seconds in position **I**.

**At temperatures above +10°C**

Warm up the engine for at least 5 seconds in position **I**.

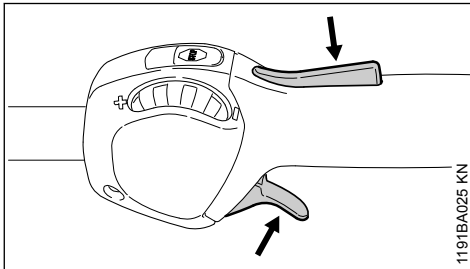

- ▶ Depress throttle trigger lockout and pull the throttle trigger – the choke knob moves to the run position **I**.

Warm up a **cold engine** at varying speeds.

**WARNING**

Make sure the carburetor is correctly adjusted. The cutting blades must not move when the engine is idling.

Your machine is now ready for operation.

**10.3 Stopping the Engine**

- ▶ Depress the momentary contact stop switch – the engine stops – release the stop switch – it springs back to the run position.

**10.4 Other Hints on Starting****Engine stalls in cold start position **I**.**

- ▶ Depress throttle trigger lockout and pull the throttle trigger – the choke knob moves to the run position **I**.
- ▶ Continue cranking in position **I** until the engine runs.

**Running engine stalls in cold start position **I** or under acceleration.**

- ▶ Continue cranking in position **I** until the engine runs.

**If the engine does not start**

- ▶ Check that all settings are correct.
- ▶ Check that there is fuel in the tank and refuel if necessary.
- ▶ Check that the spark plug boot is properly connected.
- ▶ Repeat the starting procedure.

**Engine is flooded**

- ▶ Move the choke knob to **I** and continue cranking until the engine runs.

**Fuel tank run until completely dry**

- ▶ After refueling, depress the manual fuel pump bulb at least 5 times – even if the bulb is already filled with fuel.
- ▶ Set the choke knob according to engine temperature.
- ▶ Now start the engine.

**11 Operating Instructions****11.1 During break-in period**

A factory-new machine should not be run at high revs (full throttle off load) for the first three tank fillings. This avoids unnecessary high loads during the break-in period. As all moving parts have to bed in during the break-in period, the frictional resistances in the engine are greater during this

period. The engine develops its maximum power after about 5 to 15 tank fillings.

## 11.2 During Operation

After a long period of full throttle operation, allow the engine to run for a short while at idle speed so that engine heat can be dissipated by the flow of cooling air. This protects engine-mounted components (ignition, carburetor) from thermal overload.

## 11.3 After Finishing Work

Storing for a short period: Wait for the engine to cool down. Empty the fuel tank and keep the machine in a dry place, well away from sources of ignition, until you need it again. For longer out-of-service periods – see "Storing the Machine".

## 12 Cleaning the Air Filter

### 12.1 If there is a noticeable loss of engine power

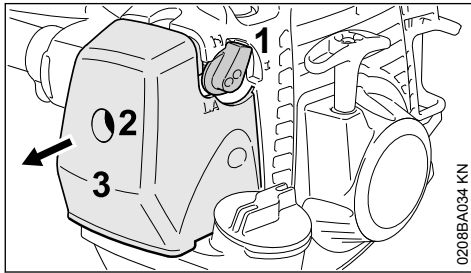

- ▶ Set knob for warm start (1) to  $\overline{I}$
- ▶ Turn screw (2) in filter cover (3) counterclockwise until the cover is loose
- ▶ Remove filter cover (3)
- ▶ Clean away loose dirt from around the filter

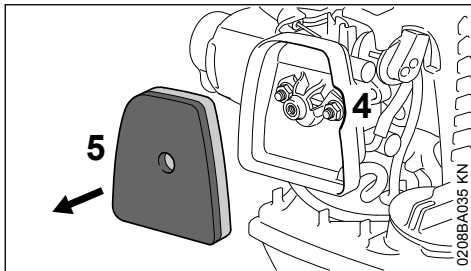

- ▶ Grip into the recess (4) in the filter housing and remove the felt filter (5)
- ▶ Replace felt filter (5) – as a temporary measure you can knock it out on the palm of your

hand or blow it out with compressed air – do not wash

### NOTICE

Replace any damaged parts!

- ▶ Insert felt filter (5) form-fittingly into the filter housing
- ▶ Set knob for warm start (1) to  $\overline{I}$
- ▶ Fit filter cover (3) – make sure not to tilt the screw (2) – insert screw and tighten

## 13 Adjusting the Carburetor

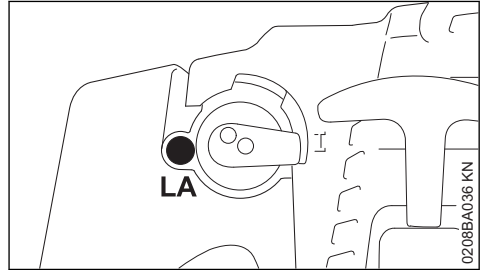

The carburetor of the machine has been adjusted at the factory for optimum performance and fuel efficiency in all operating states.

### 13.1 Setting the idle speed

#### Engine stops when idling

- ▶ Turn the idle speed screw (LA) slowly clockwise until the engine runs smoothly.

#### Cutting blades move when idling

- ▶ Turn the idle speed adjusting screw (LA) slowly counterclockwise until the cutting blades stop moving

### ! WARNING

If the cutting blades continue to move in idle even after adjustment, have the machine repaired by a STIHL servicing dealer.

## 14 Spark Plug

- ▶ If the engine is down on power, difficult to start or runs poorly at idle speed, first check the spark plug.
- ▶ Fit a new spark plug after about 100 operating hours – or sooner if the electrodes are badly eroded. Install only suppressed spark plugs of the type approved by STIHL – see "Specifications".

## 14.1 Removing the spark plug

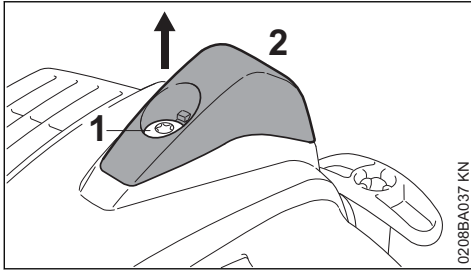

- ▶ Turn screw (1) in cap (2) until cap can be removed
- ▶ Lay down cap

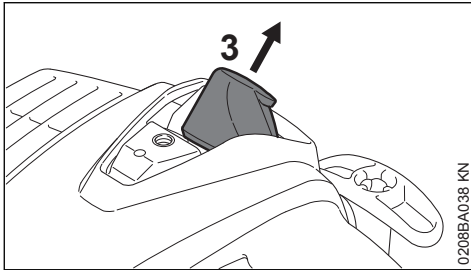

- ▶ Pull off the spark plug boot (3)
- ▶ Unscrew spark plug,

## 14.2 Checking the Spark Plug

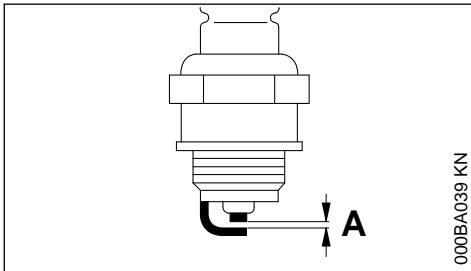

- ▶ Clean dirty spark plug.
- ▶ Check electrode gap (A) and readjust if necessary – see "Specifications".
- ▶ Rectify the problems which have caused fouling of the spark plug.

Possible causes are:

- Too much oil in fuel mix.
- Dirty air filter.
- Unfavorable running conditions.

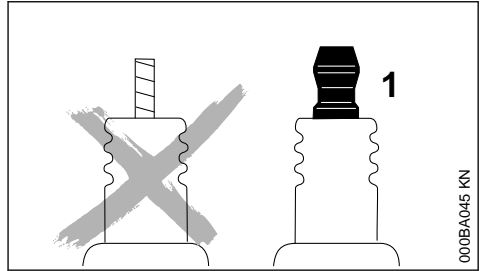

### WARNING

Arcing may occur if the adapter nut (1) is loose or missing. Working in an easily combustible or explosive atmosphere may cause a fire or an explosion. This can result in serious injuries or damage to property.

- ▶ Use resistor type spark plugs with a properly tightened adapter nut.

## 14.3 Installing the Spark Plug

- ▶ Fit the spark plug and tighten it down firmly.
- ▶ Press the boot firmly onto the spark plug.

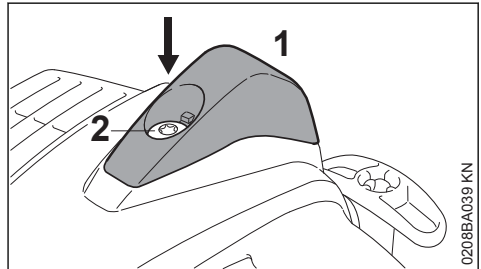

- ▶ Fit the cap (1), insert the screw (2) and tighten it down firmly.

## 15 Lubricating the Gearbox



### 15.1 Blade Drive Gear

Lubricate the blade drive gear with STIHL gear lubricant for hedge trimmers – see "Special Accessories".

### 15.1.1 HL 0° version

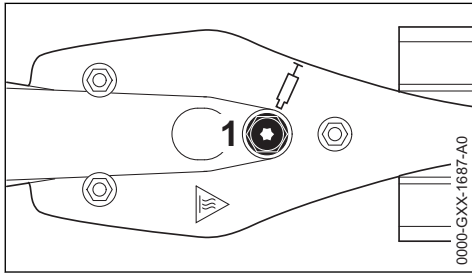

### 15.1.2 Adjustable HL 145° version

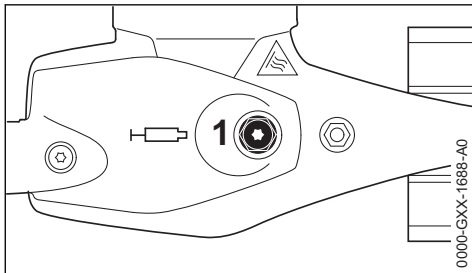

- ▶ Check the lubricant level at regular intervals of about every 25 hours of operation. Unscrew the filler plug (1) – if no grease can be seen on the inside of the filler plug, screw the tube of grease into the filler hole.
- ▶ Squeeze up to 10 g (2/5 oz) grease into the gearbox.

#### NOTICE

Do not completely fill the gearbox with grease.

- ▶ Unscrew the tube of grease from the filler hole.
- ▶ Refit the filler plug and tighten it down firmly.

## 15.2 Angle Drive Gear

Lubricate the angle drive gear with STIHL gear lubricant for hedge trimmers (special accessory).

### 15.2.1 Adjustable HL 145° version

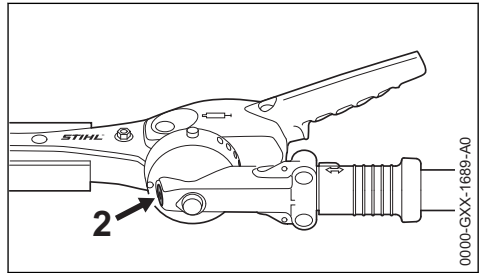

- ▶ Check the lubricant level at regular intervals of about every 25 hours of operation. Unscrew the filler plug (2) – if no grease can be seen on the inside of the filler plug, screw the tube of grease into the filler hole.
- ▶ Squeeze up to 5 g (1/5 oz) grease into the gearbox.

#### NOTICE

Do not completely fill the gearbox with grease.

- ▶ Unscrew the tube of grease from the filler hole.
- ▶ Refit the filler plug and tighten it down firmly.

## 16 Sharpening Instructions

When cutting performance and behavior begin to deteriorate, i.e. blades frequently snag on branches: Resharpener the cutting blades.

It is best to have the cutting blades resharpened by a dealer on a workshop sharpener. STIHL recommends an authorized STIHL servicing dealer.

It is also possible to use a flat crosscut sharpening file. Hold the sharpening file at the prescribed angle (see "Specifications").

- ▶ Only sharpen the cutting edge.
- ▶ Always file towards the cutting edge.
- ▶ The file only sharpens on the forward stroke – lift it off the blade on the backstroke.
- ▶ Use a whetstone to remove burr from cutting edges.
- ▶ Remove as little material as possible.
- ▶ After sharpening, clean away filing or grinding dust and then spray the cutting blades with STIHL resin solvent.

**NOTICE**

Do not operate your machine with dull or damaged cutting blades. This may cause overload and will give unsatisfactory cutting results.

## 17 Storing the Machine

If out of use for periods of about 30 days or longer

- ▶ Drain and clean the fuel tank in a well ventilated area.
- ▶ Dispose of fuel properly in accordance with local environmental requirements.
- ▶ If a manual fuel pump is fitted: Press the manual fuel pump at least 5 times.
- ▶ Start the engine and run it at idling speed until it stops.
- ▶ Clean the cutting blades, check condition and spray them with STIHL resin solvent.
- ▶ Fit the blade scabbard.
- ▶ Thoroughly clean the machine.
- ▶ Store the machine in a dry and secure location. Keep out of the reach of children and other unauthorized persons.

## 18 Inspection and Maintenance by User

### 18.1 Throttle Cable

#### 18.1.1 Checking adjustment of throttle cable

Error: Engine speed increases when only the throttle trigger is pulled.

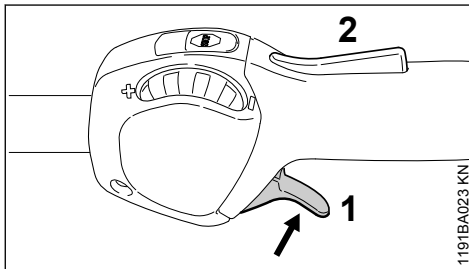

- ▶ Start the engine.
- ▶ Pull the throttle trigger (1) – do not press down the throttle trigger lockout (2).

If the engine speed increases or if the cutting blades run, the throttle cable has to be adjusted.

- ▶ Shut off the engine.
- ▶ Have throttle cable adjusted by your dealer. STIHL recommends an authorized STIHL servicing dealer.

## 19 Inspections and Maintenance by Dealer

### 19.1 Maintenance Work

STIHL recommends that you have servicing and repair work carried out exclusively by an authorized STIHL servicing dealer.

### 19.2 Antivibration Element

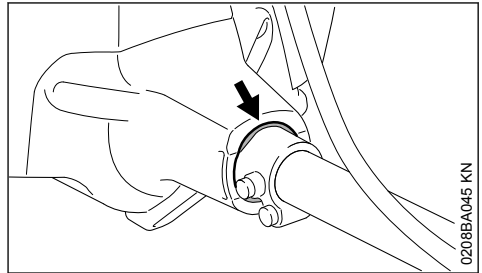

A vibration-absorbing rubber element is installed between the powerhead and the shaft. Have it checked if there are signs of wear or a noticeable increase in vibration levels.

## 20 Maintenance and Care

The following intervals apply for normal operating conditions. The specified intervals must be shortened accordingly when working for longer than normal or under difficult cutting conditions (extensive dust, etc.).		Before starting work	At the end of work and/or daily	Whenever tank is refilled	Weekly	Monthly	Annually	If faulty	If damaged	As required
Complete machine	Visual inspection (safe condition, leaks)	X		X						
	Clean		X							
	Replace any damaged parts	X								
Control handle	Function test	X		X						
Air filter	Visual inspection					X		X		
	Clean the filter housing									X
	Replace the felt filter <sup>1)</sup>								X	X
Fuel tank	Clean				X		X		X	
Manual fuel pump (if present)	check	X								
	Have repaired by a specialist dealer <sup>2)</sup>								X	
Fuel pickup body in fuel tank	Have checked by dealer <sup>2)</sup>							X		
	Have replaced by servicing dealer <sup>2)</sup>						X		X	X
Carburetor	Check idle setting, the cutting blades must not move	X		X						
	Adjust idle speed									X
Spark plug	Set electrode gap							X		
	Replace after every 100 hours of operation									
Intake port for cooling air	Visual inspection		X							
	Clean									X
Cylinder fins	Have cleaned by dealer <sup>2)</sup>						X			
All accessible screws, nuts and bolts (not adjusting screws)	Tighten									X
Anti-vibration elements	Visual inspection <sup>3)</sup>	X						X		X
	Have replaced by servicing dealer <sup>2)</sup>								X	
Cutting blades	Visual inspection	X		X						
	clean <sup>4)</sup>		X							
	sharpen <sup>4)</sup>								X	X

The following intervals apply for normal operating conditions. The specified intervals must be shortened accordingly when working for longer than normal or under difficult cutting conditions (extensive dust, etc.).		Before starting work	At the end of work and/or daily	Whenever tank is refilled	Weekly	Monthly	Annually	If faulty	If damaged	As required
Gear lubrication, gear(box) lubrication	check	X								
	top up									X
Safety information label	replace								X	
<sup>1)</sup> Only if there is a noticeable loss of engine power <sup>2)</sup> STIHL recommends STIHL dealers <sup>3)</sup> see chapter "Inspection and Maintenance by Dealer", section "Antivibration Elements" <sup>4)</sup> Afterwards spray the blades with STIHL resin solvent										

## 21 Minimize Wear and Avoid Damage

Observing the instructions in this manual helps reduce the risk of unnecessary wear and damage to the power tool.

The power tool must be operated, maintained and stored with the due care and attention described in this owner's manual.

The user is responsible for all damage caused by non-observance of the safety precautions, operating and maintenance instructions in this manual. This includes in particular:

- Alterations or modifications to the product not approved by STIHL.
- Using tools or accessories which are neither approved or suitable for the product or are of a poor quality.
- Using the product for purposes for which it was not designed.
- Using the product for sports or competitive events.
- Consequential damage caused by continuing to use the product with defective components.

### 21.1 Maintenance Work

All the operations described in the "Maintenance Chart" must be performed on a regular basis. If these maintenance operations cannot be performed by the owner, they should be performed by a servicing dealer.

STIHL recommends that you have servicing and repair work carried out exclusively by an author-

ized STIHL servicing dealer. STIHL dealers are regularly given the opportunity to attend training courses and are supplied with the necessary technical information.

If these maintenance operations are not carried out as specified, the user assumes responsibility for any damage that may occur. Among other parts, this includes:

- Damage to the engine due to neglect or deficient maintenance (e.g. air and fuel filters), incorrect carburetor adjustment or inadequate cleaning of cooling air inlets (intake ports, cylinder fins).
- Corrosion and other consequential damage resulting from improper storage.
- Damage to the machine resulting from the use of poor quality replacement parts.

### 21.2 Parts Subject to Wear and Tear

Some parts of the power tool are subject to normal wear and tear even during regular operation in accordance with instructions and, depending on the type and duration of use, have to be replaced in good time. Among other parts, this includes:

- Cutting blades
- Clutch
- Filters (air, fuel)
- Rewind starter
- Spark plug
- Components of antivibration system

## 22 Main Parts

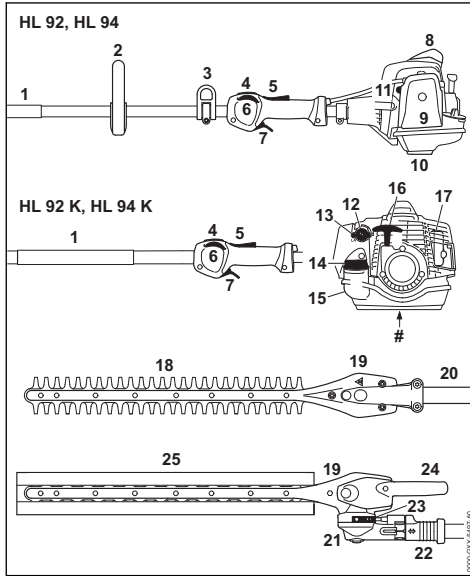

- 1 Handle hose
- 2 Loop handle
- 3 Carrying ring
- 4 Stop switch
- 5 Throttle trigger lockout
- 6 Set wheel
- 7 Throttle trigger
- 8 Spark plug boot with cap
- 9 Air filter cover
- 10 Machine support
- 11 Manual fuel pump
- 12 Choke knob
- 13 Carburetor adjusting screw
- 14 Tank cap
- 15 Fuel tank
- 16 Starter grip
- 17 Muffler
- 18 Cutting blade
- 19 Blade drive gear
- 20 Drive tube
- 21 Angle drive
- 22 Sliding sleeve
- 23 Quadrant

24 Adjusting lever

25 Blade scabbard

# Serial number

## 23 Specifications

### 23.1 Engine

Single-cylinder two-stroke engine

Displacement: 24.1cm<sup>3</sup>  
 Cylinder bore: 35 mm  
 Piston stroke: 25 mm  
 Engine power to ISO 8893: 0.9 kW  
 (1.2 hp) at 8500 1/min  
 Idle speed: 2800 rpm  
 Cut-off speed: 9300 rpm  
 (nominal value):

### 23.2 Ignition system

Magneto ignition system, electronic

Spark plug (sup-pressed): NGK CMR6H,  
 BOSCH USR  
 4AC  
 Electrode gap: 0.5 mm

### 23.3 Fuel system

Fuel tank capacity: 540 cm<sup>3</sup> (0.54 l)

### 23.4 Weight

Weight without fuel, with 0°  
 adjustable gearbox, 500 mm

HL 94: 5.7 kg  
 HL 94 K: 5.2 kg

Weight without fuel, with 0°  
 adjustable gearbox, 600 mm

HL 94: 5.8 kg  
 HL 94 K: 5.3 kg

Weight without fuel, with 145°  
 adjustable gearbox, 500 mm

HL 94: 6.1 kg  
 HL 94 K: 5.6 kg

Weight without fuel, with 145°  
 adjustable gearbox, 600 mm

HL 94: 6.2 kg  
 HL 94 K: 6.1 kg

### 23.5 Cutting blades

Blade type: Double-sided  
 Blade length: 500 mm,  
 600 mm

Tooth spacing: 34 mm  
 Tooth height: 22 mm  
 Sharpening angle: 45° relative to  
 blade level



## 23.6 Noise and vibration values

When determining sound and vibration values, idling and the nominal maximum engine speed are taken into account at a ratio of 1:4.

For further details on compliance with the Directive for Employers on Vibration 2002/44/EEC, see

[www.stihl.com/vib](http://www.stihl.com/vib)

### Sound pressure level $L_{peq}$ in accordance with ISO 22868:

HL 94:	91 dB(A)
HL 94 K:	92 dB(A)

### Sound power level $L_{weq}$ in accordance with ISO 22868:

HL 94:	106 dB(A)
HL 94 K:	107 dB(A)

### 23.6.1 HL 0°, 500 mm

#### Vibration value $a_{hv,eq}$ in accordance with ISO 22867:

HL 94, left hand on handle hose:	
Handle hose:	4.8 m/s <sup>2</sup>
Control handle:	6.3 m/s <sup>2</sup>

#### Vibration value $a_{hv,eq}$ in accordance with ISO 22867:

HL 94, left hand on loop handle:	
Loop handle:	6.9 m/s <sup>2</sup>
Control handle:	6.1 m/s <sup>2</sup>

### 23.6.2 HL 0°, 600 mm

#### Vibration value $a_{hv,eq}$ in accordance with ISO 22867:

HL 94, left hand on handle hose:	
Handle hose:	5.6 m/s <sup>2</sup>
Control handle:	6.1 m/s <sup>2</sup>

#### Vibration value $a_{hv,eq}$ in accordance with ISO 22867:

HL 94, left hand on loop handle:	
Loop handle:	7.9 m/s <sup>2</sup>
Control handle:	6.2 m/s <sup>2</sup>

### 23.6.3 HL 145°, 500 mm

#### Vibration value $a_{hv,eq}$ in accordance with ISO 22867:

HL 94, left hand on handle hose:	
Handle hose:	4.9 m/s <sup>2</sup>
Control handle:	4.9 m/s <sup>2</sup>

#### Vibration value $a_{hv,eq}$ in accordance with ISO 22867:

HL 94, left hand on loop handle:	
Loop handle:	6.1 m/s <sup>2</sup>
Control handle:	5.4 m/s <sup>2</sup>

### 23.6.4 HL 145°, 600 mm

#### Vibration value $a_{hv,eq}$ in accordance with ISO 22867:

HL 94, left hand on handle hose:	
Handle hose:	4.9 m/s <sup>2</sup>
Control handle:	4.9 m/s <sup>2</sup>

#### Vibration value $a_{hv,eq}$ in accordance with ISO 22867:

HL 94, left hand on loop handle:	
Loop handle:	6.5 m/s <sup>2</sup>
Control handle:	5.4 m/s <sup>2</sup>

### 23.6.5 HL 0°, 500 mm

#### Vibration value $a_{hv,eq}$ in accordance with ISO 22867:

HL 94 K:	
Handle hose:	6.2 m/s <sup>2</sup>
Control handle:	5.9 m/s <sup>2</sup>

### 23.6.6 HL 0°, 600 mm

#### Vibration value $a_{hv,eq}$ in accordance with ISO 22867:

HL 94 K:	
Handle hose:	6.0 m/s <sup>2</sup>
Control handle:	6.5 m/s <sup>2</sup>

### 23.6.7 HL 145°, 500 mm

#### Vibration value $a_{hv,eq}$ in accordance with ISO 22867:

HL 94 K:	
Handle hose:	7.0 m/s <sup>2</sup>
Control handle:	7.2 m/s <sup>2</sup>

### 23.6.8 HL 145°, 600 mm

#### Vibration value $a_{hv,eq}$ in accordance with ISO 22867:

HL 94 K:	
Handle hose:	6.4 m/s <sup>2</sup>
Control handle:	6.4 m/s <sup>2</sup>

The noise and vibration data of further approved tool attachments have been listed in the User Manual supplied with each tool attachment.

The K-factor in accordance with Directive 2006/42/EC is 2.0 dB(A) for the sound pressure level and sound power level; the K-factor in accordance with Directive 2006/42/EC is 2.0 m/s<sup>2</sup> for the vibration level.

## 23.7 REACH

REACH is an EC regulation and stands for the Registration, Evaluation, Authorization and Restriction of Chemical substances.

For information on compliance with the REACH regulation (EC) No. 1907/2006 see

[www.stihl.com/reach](http://www.stihl.com/reach)

## 23.8 Exhaust Emissions

The CO<sub>2</sub> value measured in the EU type approval procedure is specified at

[www.stihl.com/co2](http://www.stihl.com/co2)

in the product-specific technical data.

The measured CO<sub>2</sub> value was determined on a representative engine in accordance with a standardized test procedure under laboratory conditions and does not represent either an explicit or implied guarantee of the performance of a specific engine.

The applicable exhaust emission requirements are fulfilled by the intended usage and maintenance described in this User Manual. The operating license shall be void if the engine is modified in any way.

## 24 Maintenance and Repairs

Users of this machine may only carry out the maintenance and service work described in this user manual. All other repairs must be carried out by a servicing dealer.

STIHL recommends that you have servicing and repair work carried out exclusively by an authorized STIHL servicing dealer. STIHL dealers are regularly given the opportunity to attend training courses and are supplied with the necessary technical information.

When repairing the machine, only use replacement parts which have been approved by STIHL for this power tool or are technically identical. Only use high-quality replacement parts in order to avoid the risk of accidents and damage to the machine.

STIHL recommends the use of original STIHL replacement parts.

Original STIHL parts can be identified by the STIHL part number, the **STIHL** logo and the STIHL parts symbol  (the symbol may appear alone on small parts).

## 25 Disposal

Contact the local authorities or your STIHL servicing dealer for information on disposal.

Improper disposal can be harmful to health and pollute the environment.

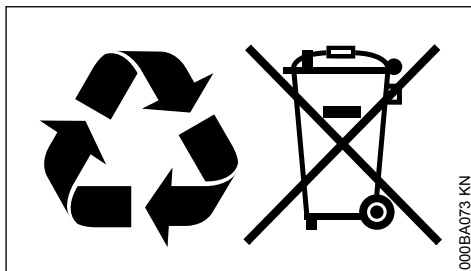

- ▶ Take STIHL products including packaging to a suitable collection point for recycling in accordance with local regulations.
- ▶ Do not dispose with domestic waste.

## 26 EC Declaration of Conformity

ANDREAS STIHL AG & Co. KG  
Badstr. 115  
D-71336 Waiblingen

Germany

declares under its sole responsibility that

Designation:	Long-reach hedge trimmer
Make:	STIHL
Series:	HL 94 HL 94 K
Serial identification number:	4243
Displacement	
All HL 94 models:	24.1cm <sup>3</sup>

conforms to the relevant provisions of Directives 2011/65/EU, 2006/42/EC, 2014/30/EU and 2000/14/EC and has been developed and manufactured in compliance with the following standards in the versions valid on the date of production:

EN ISO 10517, EN 55012, EN 61000-6-1

The measured and the guaranteed sound power level have been determined in accordance with Directive 2000/14/EC, Annex V, and standard ISO 11094.

### Measured sound power level

All HL 94 models:	101 dB(A)
All HL 94 K models:	101 dB(A)

### Guaranteed sound power level

All HL 94 models:	103 dB(A)
All HL 94 K models:	103 dB(A)

Technical documents deposited at:

ANDREAS STIHL AG & Co. KG  
Produktzulassung

The year of manufacture and serial number are indicated on the power tool.

Waiblingen, 2022-08-01

ANDREAS STIHL AG & Co. KG

pp



Robert Olma, Vice President, Regulatory Affairs  
& Global Governmental Relations



## 27 UKCA Declaration of Conformity

ANDREAS STIHL AG & Co. KG  
Badstr. 115  
D-71336 Waiblingen

Germany

declare under our sole responsibility that

Designation:	Long-reach hedge trimmer
Make:	STIHL
Series:	HL 94 HL 94 K
Serial identification number:	4243
Displacement All HL 94 models:	24.1cm <sup>3</sup>

conforms to the relevant provisions of UK regulations The Restriction of the Use of Certain Hazardous Substances in Electrical and Electronic Equipment Regulations 2012, Supply of Machinery (Safety) Regulations 2008, Electromagnetic Compatibility Regulations 2016 and Noise Emission in the Environment by Equipment for use Outdoors Regulations 2001 and has been manufactured in compliance with the following standards in the versions valid on the date of production:

EN ISO 10517, EN 55012, EN 61000-6-1

The measured and guaranteed sound power levels were determined in accordance with the UK regulation Noise Emission in the Environment by Equipment for Use Outdoors Regulations 2001, Schedule 8, using the ISO 11094 standard.

### Measured sound power level

All HL 94 models:	101 dB(A)
All HL 94 K models:	101 dB(A)

### Guaranteed sound power level

All HL 94 models:	103 dB(A)
All HL 94 K models:	103 dB(A)

Technical documents deposited at:

ANDREAS STIHL AG & Co. KG

The year of manufacture and serial number are indicated on the product.

Waiblingen, 01.08.2022

ANDREAS STIHL AG & Co. KG

pp



Robert Olma, Vice President, Regulatory Affairs  
& Global Governmental Relations



## 28 Addresses

[www.stihl.com](http://www.stihl.com)

[www.stihl.com](http://www.stihl.com)



0458-519-0121-F



0458-519-0121-F