

TS 480i, 500i

**STIHL**



2 - 35      Instruction Manual



# Contents

|    |                                                |    |
|----|------------------------------------------------|----|
| 1  | Guide to Using this Manual.....                | 2  |
| 2  | Safety Precautions and Working Techniques..... | 2  |
| 3  | Sample Applications.....                       | 10 |
| 4  | Cutting Wheels.....                            | 13 |
| 5  | Composite Abrasive Wheels.....                 | 13 |
| 6  | Diamond Abrasive Wheels.....                   | 14 |
| 7  | Electronic Water Control.....                  | 16 |
| 8  | Assembling the cast arm and guard .....        | 17 |
| 9  | Tensioning the ribbed V-belt.....              | 21 |
| 10 | Mounting an Abrasive Wheel.....                | 22 |
| 11 | Fuel.....                                      | 23 |
| 12 | Fueling.....                                   | 24 |
| 13 | Starting / Stopping the Engine.....            | 25 |
| 14 | Air Filter System.....                         | 26 |
| 15 | STIHL Injection.....                           | 27 |
| 16 | Spark Plug.....                                | 27 |
| 17 | Replacing the V-belt.....                      | 28 |
| 18 | Cut-off Machine Cart.....                      | 29 |
| 19 | Storing the Machine.....                       | 29 |
| 20 | Maintenance and Care.....                      | 30 |
| 21 | Minimize Wear and Avoid Damage.....            | 31 |
| 22 | Main Parts.....                                | 32 |
| 23 | Specifications.....                            | 32 |
| 24 | Maintenance and Repairs.....                   | 33 |
| 25 | Disposal.....                                  | 34 |
| 26 | EC Declaration of Conformity.....              | 34 |
| 27 | UKCA Declaration of Conformity.....            | 34 |

## 1 Guide to Using this Manual

### 1.1 Pictograms

Pictograms that appear on the machine are explained in this Instruction Manual.

Depending on the machine and equipment version, the following pictograms may appear on the machine.



Fuel tank; fuel mixture of gasoline and engine oil



Actuate decompression valve



Actuate manual fuel pump



Water connection, shut-off cock



Tensioning nut for belt



Pull starter grip

### 1.2 Symbols in text



**WARNING**

Warning where there is a risk of an accident or personal injury or serious damage to property.

*NOTICE*

Caution where there is a risk of damaging the machine or its individual components.

### 1.3 Engineering improvements

STIHL's philosophy is to continually improve all of its products. For this reason we may modify the design, engineering and appearance of our products periodically.

Therefore, some changes, modifications and improvements may not be covered in this manual.

## 2 Safety Precautions and Working Techniques



Special safety precautions must be taken when working with the cut-off machine, due to the very high rotational speed of the abrasive wheel.



It is important that you read and understand the User Manual before commissioning and keep it in a safe place for future reference. Non-observance of the safety precautions may result in serious or even fatal injury.

Observe all applicable local safety regulations, e.g. by trade organizations, social insurance institutions, labor safety authorities etc.

As for employers within the European Community, the provision 2009/104/EC is binding – Safety and health protection with the use of machines and devices by employees at work.

If you have never used a power tool before: have your STIHL dealer or other specialist show you how to operate the machine – or attend one of the special training courses.

Minors should never be allowed to use the machine – except for apprentices over the age of 16 when working under supervision.

Children, animals and onlookers must not be allowed near the machine.

When not using the machine, it must be laid down in such a way that it does not endanger anyone. Ensure that the machine cannot be used without authorization.

The user is responsible for accidents or risks involving third parties or their property.

Do not lend or rent your power tool without the User Manual. Be sure that anyone using it understands the information contained in this manual.

The use of machines that emit noise may be limited to certain hours of the day as specified by national and/or regional or local regulations.

Anyone operating the machine must be well rested, in good physical health and in good mental condition.

If you have any condition that might be aggravated by strenuous work, check with your doctor before operating a machine.

If you have a pacemaker: The ignition system of your machine produces an electromagnetic field of very low intensity. This field may interfere with some pacemakers. STIHL recommends that persons with pacemakers consult their physician and the pacemaker manufacturer to reduce any health risk.

Anyone who has consumed alcohol or drugs or medicines affecting their ability to react must not operate a power tool.

Postpone the work if the weather is bad (snow, ice, wind) – **higher risk of accidents!**

The machine may only be used for cutting. It is not suitable for cutting wood or wooden objects.

Asbestos dust is extremely toxic - the machine must therefore **never be used to cut asbestos!**

Other uses are not permitted and may lead to accidents or damage to the machine.

Never attempt to modify your power tool in any way since this may increase the risk of personal injury. STIHL excludes all liability for personal injury and damage to property caused while using unauthorized attachments.

Only use abrasive wheels or accessories which have been approved by STIHL for this machine or which are technically equivalent. If you have

any questions in this respect, consult your dealer. Only use high-quality abrasive wheels and attachments. In order to avoid the risk of accidents and damage to the machine.

STIHL recommends the use of genuine STIHL abrasive wheels and accessories. They are specifically designed to match the product and meet your performance requirements.

Do not use a high-pressure washer to clean the power tool. The solid jet of water may damage parts of the unit.

Do not spray the power tool with water.



Never use circular saw blades, carbide, rescue or wood cutting attachments or saws of any kind – **these may cause fatal injuries!** Instead of uniformly removing particles as when cutting with an abrasive wheel, the teeth of a circular saw blade may snag in the material. This causes the machine to react in a highly aggressive manner with uncontrolled and extremely dangerous kickback.

## 2.1 Clothing and equipment

Wear proper protective clothing and equipment.



Clothing must be robust but allow complete freedom of movement. Wear close-fitting clothes such as a boiler suit, not a work coat.

When cutting steel, always wear clothing made of barely flammable material (e.g., leather or cotton with flame-retardant finish) – no man made fibers – **risk of fire due to flying sparks!**

Clothing must be free from flammable deposits (chips, fuel, oil, etc.).

Do not wear clothes that may be caught by moving parts – no scarf, no tie, no jewelry. Tie up and confine long hair above your shoulders.



Wear steel-toed **safety boots** with non-slip soles.



### WARNING



To reduce the risk of eye injuries, wear close-fitting safety glasses in accordance with European Standard EN 166. Make sure the safety glasses are a snug fit.

Wear "personal" sound protection, e.g. ear defenders.

Wear a safety hard hat where there is a danger of head injuries from falling objects.

Dust (e.g., crystalline material from the object being cut), fumes and smoke may be produced while cutting - **health hazard!**

Always wear a **dust mask** if dust is generated.

If fumes or smoke are anticipated (e. g., when cutting composite materials), wear **respiratory protection**.



Wear sturdy protective gloves made of a resistant material (e. g. leather).

STIHL can supply a comprehensive range of personal protective equipment.

## 2.2 Transporting the machine

Always stop the engine.

Carry the device by the handlebar only – abrasive wheel pointing to the rear – hot muffler away from the body.

To **avoid serious burn injuries**, avoid touching hot parts of the machine, especially the surface of the muffler.

Never transport the engine-driven device with attached abrasive wheel – **risk of breakage!**

By vehicle: When transporting in a vehicle, properly secure your machine to prevent turnover, damage and fuel spillage.

## 2.3 Refueling



**Gasoline is highly flammable** – keep away from fire or flame – do not spill any fuel – no smoking.

Always **shut off the engine** before refueling.

Do not fuel a hot engine – **fuel may spill and cause a fire.**

Open the fuel cap carefully to allow any pressure build-up in the tank to release slowly and avoid fuel spillage.

Only refuel the machine in a well ventilated place. If fuel has been spilled, immediately clean the machine – do not allow your clothes to be splashed with fuel. If that happens, change your clothes at once.

Dust may collect on the engine unit. If dust gets mixed with fuel – risk of fire. For this reason, ensure that the dust is always removed.



Check for fuel leakage! Never start the engine if fuel has been spilled or is leaking – **Fatal burns may result!**

### 2.3.1 Bayonet-type fuel cap

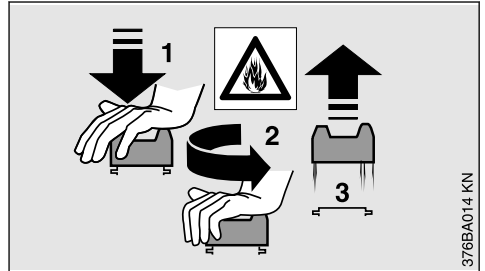

Never use a tool to open or close the bayonet-type fuel cap. This could damage the cap and cause fuel to leak out.

Close the bayonet-type fuel cap carefully after refueling.

## 2.4 Cut-off machine, spindle bearing

Correct spindle bearings ensure the concentricity and axial running of the diamond abrasive wheel – if necessary, get it checked by an approved dealer.

## 2.5 Abrasive cutting wheels

### 2.5.1 Selecting the abrasive cutting wheels

Abrasive cutting wheels must be approved for freehand cutting. Do not use other cutting wheels and attachments – **risk of accident!**

Abrasive cutting wheels are suitable for different materials: Observe the identification of the abrasive cutting wheels.

STIHL generally recommends wet cutting.



Observe the outer diameter of the abrasive wheel.



Spindle hole diameter of the abrasive wheel and shaft of cut-off machine must match.

Check the spindle hole for damage. Do not use abrasive cutting wheels with a damaged spindle hole – **risk of accident!**



The permissible speed of the abrasive cutting wheel must be equal to or greater than the maximum spindle speed of the cut-off machine. – Refer to the chapter "Specifications".

Before fitting a used abrasive cutting wheel, check that it is not cracked, chipped, undercut or uneven, and does not display any signs of core fatigue or overheating (discoloration); check also the spindle hole is not damaged.

Never use cracked, chipped or bent abrasive cutting wheels.

Substandard and/or unapproved diamond abrasive wheels can shimmy during cutting. This shimmying can cause such diamond abrasive wheels to be abruptly braked or become stuck in the cut – **Danger of kickback! Kickback can result in fatal injuries!** Diamond abrasive wheels that shimmy constantly or even only intermittently must be replaced immediately.

Never straighten diamond abrasive wheels.

Do not use an abrasive cutting wheel which has fallen to the ground – damaged abrasive cutting wheels may break – **risk of accident!**

Observe the expiration date where composite resin abrasive cutting wheels are concerned.

### 2.5.2 Fitting abrasive cutting wheels

Inspect the spindle of the cut-off machine. Do not use a cut-off machine if the spindle is damaged – **risk of accident!**

Note the arrows indicating the direction of rotation on diamond abrasive wheels.

Position the front pressure plate – tighten up the tensioning screw – rotate the abrasive cutting wheel by hand and take a sight check for concentricity and axial running.

### 2.5.3 Storing abrasive cutting wheels

Store abrasive wheels in a dry and frost-free place, on an even surface, at constant temperature – **risk of breakage and splintering!**

Always protect abrasive cutting wheels against sudden impact with the floor or objects.

## 2.6 Before starting

Inspect the cut-off machine for safe-to-operate state – observe the respective chapters in the User Manual:

- Check the fuel system for leaks, especially the visible parts, e. g., fuel cap, hose connections, manual fuel pump (only in machines with a

manual fuel pump). In case of leakage and damage, do not start the engine – **risk of fire!** Have the machine serviced by a dealer before using it

- The abrasive wheel must be suitable for the material to be cut. It must be in good condition and fitted correctly (direction of rotation, secure).
- Inspect the abrasive wheel guard for tight seat – if loose, contact your specialist dealer.
- Smooth action of throttle trigger and throttle trigger lockout – throttle trigger must return automatically to idle position
- Stop switch can be moved easily to **STOP** or **0**
- Check that the spark plug boot is secure – a loose boot may cause sparking that could ignite combustible fumes **and cause a fire!**
- Never attempt to modify the controls or safety devices.
- Keep the handles clean, dry and free of oil as well as dirt – important for safe guiding of the cut-off machine.
- For wet applications, provide sufficient water

**To reduce the risk of personal injury**, do not operate your power tool if it is damaged or not properly assembled!

## 2.7 Starting the engine

Start the engine at least 3 meters from the fueling spot, outdoors only.

On even ground, ensure a firm and secure footing and hold the engine-driven device firmly – the abrasive cutting wheel must not touch any objects or the ground and must not be in cutting action.

The abrasive wheel may begin to rotate as soon as the machine is started

The machine is operated by a single person only – do not allow any person to stay within the working area – nor with starting.

Do not drop start your machine – the correct starting procedure is described in the User Manual.

After releasing the throttle trigger, the abrasive wheel keeps on running for a while – **danger of injury due to coasting effect!**

## 2.8 Holding and guiding the machine

The cut-off machine may only be used for hand-held cutting or when mounted on a STIHL Cut-quick cart.

### 2.8.1 Hand-held cutting

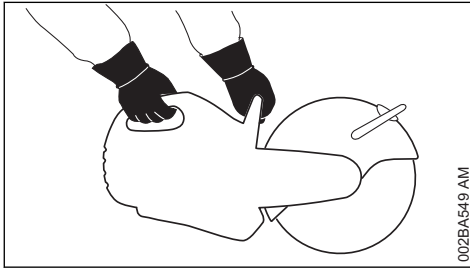

Always hold the machine **firmly with both hands**: Right hand on the rear handle – even if you are left-handed. To ensure safe control, wrap your fingers tightly around both handles.

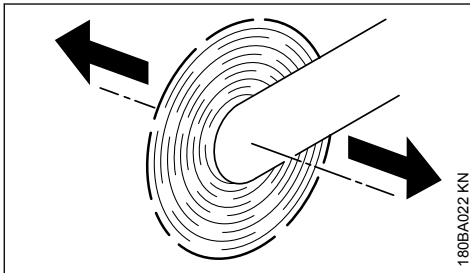

When a cut-off machine with an abrasive cutting wheel rotating is moved in the direction of the arrow, a force is produced which causes the machine to tip sideways.

The object to be cut off has to be firmly supported. Always guide the machine towards the workpiece – never the other way round.

### 2.8.2 Cutquik cart

STIHL cut-off machines can be mounted onto a STIHL Cutquik cart.

### 2.9 Deflector

The adjustment range of the guard is determined by a stop pin. Never push the guard over the stop pin.

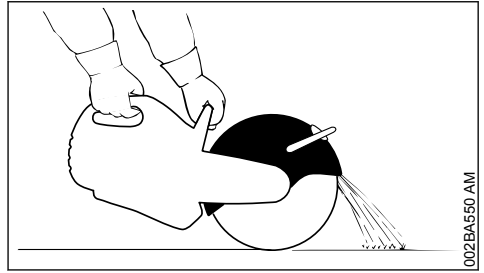

Set the abrasive cutting wheel guard correctly: Guide particles of material away from the user and machine.

Note the direction of flight of the removed particles of material.

### 2.10 While working

In the event of impending danger or in an emergency, switch off the engine immediately by moving the stop switch to **STOP** or **0**.

Check for correct idling, so that the abrasive cutting wheel is no longer driven when the throttle trigger is released and comes to a complete halt.

Regularly check idling. If the abrasive wheel turns when the machine is idling, have the machine repaired by the specialist dealer.

Keep clear the working area – bear in mind obstacles, holes and pitches.

Take special care in slippery conditions – **damp, snow, ice**, on slopes or uneven ground.

Don not work while standing on a ladder – not on an insecure support – not over your shoulder height – not with one hand only – **risk of accident!**

Make sure you always have a firm and secure footing.

Do not work alone – keep within calling distance of others in case help is needed.

Keep out further persons from the working area – maintain sufficiently large distance to additional persons to protect them from noise and flying objects.

Be particularly alert and cautious when wearing hearing protection because your ability to hear warnings (shouts, alarms, etc.) is restricted.

Take a break in good time before you get tired.

Work calmly and carefully – in daylight conditions and only when visibility is good. Proceed with caution, do not put others in danger.



As soon as the engine is running, the power machine generates toxic exhaust gas. As soon as the engine is running, the power machine generates toxic exhaust gas. These gases may be odorless and invisible and may contain unburned hydrocarbons and benzene. Never run the engine indoors or in poorly ventilated locations, even if your model is equipped with a catalytic converter.

Ensure proper ventilation when working in trenches, hollows or similar locations – **risk of fatal injury from breathing toxic fumes!**

Stop work immediately if you start suffering from nausea, headaches, impaired vision (e.g. your field of vision gets smaller), impaired hearing, dizziness, or impaired concentration – these symptoms may possibly be the result of too-high exhaust gas concentration – **Risk of accidents!**

**To reduce the risk of fire, do not smoke** while operating or standing near your power tool.

If your power tool is subjected to unusually high loads for which it was not designed (e.g. heavy impact or a fall), always check that it is in good condition before continuing work – see also "Before Starting". Check in particular that the fuel system has no leaks and the safety equipment is fully operative. Never use a power tool that is no longer safe to operate. In case of doubt, contact a dealer.

Never touch a rotating abrasive cutting wheel with your hand or any other part of your body.

Examine the workplace. Avoid all danger due to damaged piping or electrical wiring.

The machine must not be used near inflammable substances or gases.

Do not cut into pipes, metal tanks or other containers if you are not sure that they do not contain any volatile or inflammable substances.

Never leave the machine unattended with the engine running. Stop the engine before leaving the machine unattended (e. g. for breaks).

Before putting the cut-off machine down on the ground:

- Shut off the engine
- Wait until the abrasive cutting wheel has come to a standstill or brake the abrasive cutting wheel until it comes to a standstill by carefully touching a hard surface (e.g., concrete slab)



Frequently inspect the abrasive cutting wheel – replace it right away if there are visible cracks, buckling or other damage (for example, overheating) – **risk of accident due to breakage!**

In the event of changes in cutting behavior (e. g., increased vibration, reduced cutting performance), stop work and eliminate the causes of the changes.

## 2.11 Reactive forces

The most frequently occurring reactive forces are kickback and pull-in.



**Danger of kickback – Kickback can result in fatal injuries.**

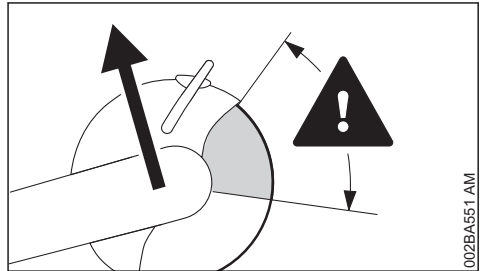

Kickback occurs when the cut-off machine is suddenly thrown up and back in an uncontrolled arc towards the operator.

**Kickback occurs if, for example, the abrasive cutting wheel**

- gets jammed – primarily in its upper quarter, or
- is abruptly braked through friction contact with a solid object

**To reduce the risk of kickback**

- Work cautiously and avoid situations which could cause kickback.
- Hold the cut-off machine firmly with both hands and maintain a secure grip

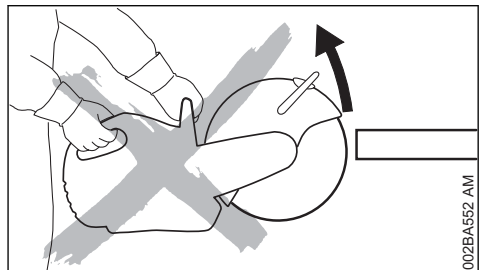

- If possible, avoid using the upper quarter of the abrasive cutting wheel for cutting. Use extreme caution when guiding the abrasive cutting wheel into a cut, do not twist or push into the cut

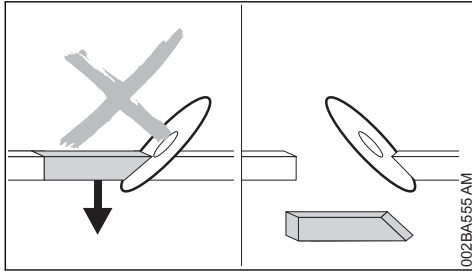

- Avoid any wedge effect - the severed part must not brake the abrasive cutting wheel
- Always be aware that the object to be cut may move and other factors may cause the cut to close and jam the abrasive cutting wheel.
- The object to be cut must be secured and supported so that the kerf remains open during and after cutting
- Objects to be cut must therefore be fully supported and must be secured against rolling away, slipping off or vibrations

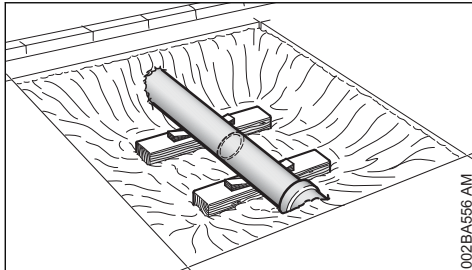

- Support an uncovered pipe stable and solid, if necessary, use wedges – always bear in mind a proper support and ground – material may crumble away,
- Always work with water and wet cutting when using diamond abrasive wheels
- Depending on the version, composite resin abrasive cutting wheels are suitable only for dry cutting or only for wet cutting. Always use wet cutting with composite resin abrasive cutting wheels that are suitable only for wet cutting

### 2.11.1 Pull away from

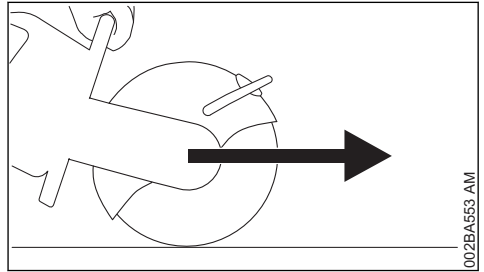

The cut-off machine pulls forward, away from the user, when the abrasive wheel touches the object to be cut from above.

### 2.12 Working – cutting off



The abrasive cutting wheel must be guided straight in the cut, without tilting. Never exert lateral pressure on the abrasive cutting wheel.



Do not use for lateral grinding or scrubbing.

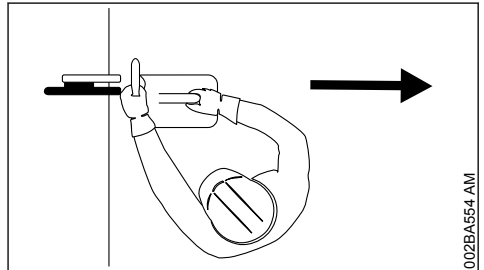

Do not stand in line with the abrasive wheel. Ensure sufficient freedom of movement, especially in construction trenches there must be sufficient space for the user and for the part being cut to fall.

Do not lean too far forwards and never bend over the abrasive wheel when the guard has been pulled back.

Do not work above shoulder height.

The cut-off machine may only be used for cutting. It must not be used as a lever or shovel.

Do not press down on the cut-off machine

Always decide the cutting direction before positioning the cut-off machine. After that, do not change the cutting direction. Never push or hit with the device into the cutting gap – do not let



the concrete cutter fall into the cutting depth – **risk of breakage!**

Diamond abrasive cutting wheels: If cutting performance begins to deteriorate, check the sharpness of the diamond abrasive wheel, resharpen as needed. To do this, briefly cut through abrasive material, e. g., sandstone, aerated concrete or asphalt.

At the end of the cut, the cut-off machine is no longer supported by the abrasive wheel in the cut. The user has to absorb the weight force – **risk of loss of control!**



When cutting steel: glowing metal particles **may cause fires!**

Keep water and sludge away from alive electrical cables – **risk of electric shock!**

Drag the abrasive wheel into the workpiece – do not push it into the material. Do not correct severing cuts with the cut-off machine. Do not re-cut – remove left webs or breaking edges (for example, with a hammer).

When applying diamond abrasive wheels, take a wet cut – for example, use the STIHL water connector.

Depending on the version, composite resin abrasive cutting wheels are suitable only for dry cutting or only for wet cutting.

When using composite resin abrasive cutting wheels which are suited for wet cuts only, take such wet cuts only – for example, use the STIHL water connector.

When using composite resin abrasive cutting wheels which are suited for dry cuts only, take such dry cuts only. If however composite resin abrasive cutting wheels of this type become wet, their cutting performance is reduced and they become dull. If composite resin abrasive cutting wheels of this type become wet while working (e. g., due to puddles or water in pipes), do not increase the cutting pressure, but continue working with the same pressure – **risk of breakage!** Use up such composite resin abrasive cutting wheels immediately.

### 2.12.1 Cutquik cart

Clear a path for the Cutquik cart. If the Cutquik cart is pushed over objects, the abrasive wheel may become wedged in the cut and **shatter!**

## 2.13 Vibrations

Prolonged use of the power tool may result in vibration-induced circulation problems in the hands (whitefinger disease).

No general recommendation can be given for the length of usage because it depends on several factors.

The period of usage is prolonged by:

- Hand protection (wearing warm gloves)
- Work breaks

The period of usage is shortened by:

- Any personal tendency to suffer from poor circulation (symptoms: frequently cold fingers, tingling sensations).
- Low outside temperatures.
- The force with which the handles are held (a tight grip restricts circulation).

Continual and regular users should monitor closely the condition of their hands and fingers. If any of the above symptoms appear (e.g. tingling sensation in fingers), seek medical advice.

## 2.14 Maintenance and repairs

The machine must be serviced regularly. Do not attempt any maintenance or repair work not described in the Instruction Manual. All other work should be carried out by a servicing dealer.

STIHL recommends that maintenance and repair work be carried out only by authorized STIHL dealers. STIHL dealers receive regular training and are supplied with technical information.

Use only high-quality spare parts. Otherwise, there may be a risk of accidents or damage to the machine. Contact a servicing dealer if in doubt.

STIHL recommends the use of genuine STIHL spare parts. Such parts have been optimized for the machine and the user's requirements.

Before starting any maintenance or repair work and before cleaning the machine, always **stop the engine – risk of injury!**

To reduce the **risk of fire** due to ignition outside the cylinder, move the stop switch to **STOP** or **0** before turning the engine over on the starter with the spark plug boot removed or the spark plug unscrewed.

Do not service or store the machine near a naked flame – **risk of fire** due to the fuel.

Check fuel cap regularly for tightness.

Use only spark plugs that are in perfect condition and have been approved by STIHL – see "Specifications".

Inspect ignition lead (insulation in good condition, secure connection).

Check that the muffler is in perfect working condition.

Do not use the machine if the muffler is damaged or missing – **risk of fire! – Hearing damage!**

Never touch a hot muffler – **risk of burns!**

Check the rubber buffers underneath the machine – the housing must not rub against the ground – **risk of damage!**

The condition of the antivibration elements influences vibration behavior – inspect antivibration elements periodically.

## 3 Sample Applications

### 3.1 Water must always be used for wet cutting when working with diamond abrasive wheels

#### 3.1.1 Extend service life and increase cutting speed

Always ensure a supply of water to the abrasive wheel.

#### 3.1.2 Binding dust

The abrasive wheel must be supplied with at least 0.6 liters of water per minute.

#### 3.1.3 Water attachment

- Water attachment on the machine for all types of water supplies
- Pressurized water tank 10 l for binding dust
- water tank usable on the cut-off machine cart for binding dust

### 3.2 Use composite resin abrasive wheels with or without water – depending on version

Depending on the version, resin abrasive wheels are only suitable for dry cutting or only for wet cutting.

#### 3.2.1 Composite resin abrasive wheels suitable only for dry cutting

During dry cutting, wear a suitable dust mask.

If fumes or smoke are anticipated (e. g., when cutting composite materials), wear **respiratory protection**.

#### 3.2.2 Composite resin abrasive wheels suitable only for wet cutting



Use abrasive wheel only with water.

To bind dust, the abrasive wheel must be supplied with at least 1 liter of water per minute. To avoid a reduction in cutting performance, the abrasive wheel must be supplied with not more than 4 liters of water per minute.

After using the abrasive wheel, the wheel should be allowed to continue spinning at operating speed for approx. 3 to 6 seconds without water in order to spin off the water remaining on it.

- Water attachment on the machine for all types of water supplies
- Pressurized water tank 10 l for binding dust
- water tank usable on the cut-off machine cart for binding dust

### 3.3 Observe with diamond and composite resin abrasive wheels

#### 3.3.1 Objects to be cut

- Must be fully supported
- Must be secured so it cannot roll or slip off
- Must be prevented from vibrating

#### 3.3.2 Severed parts

With openings, recesses, etc., the sequence of the cuts is important. Always make the last cut so that the abrasive wheel does not become jammed and so that the operator is not endangered by the severed or separated part.

If necessary, leave small ridges that hold the part that is to be separated in position. Break these ridges later.

Before finally separating the part, determine:

- how heavy the part is
- how it can move after separation
- whether it is under tension

When breaking out the part, do not endanger assistants.

### 3.4 Cut in several passes

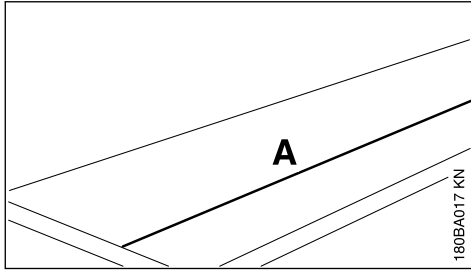

- ▶ Mark cutting line (A)

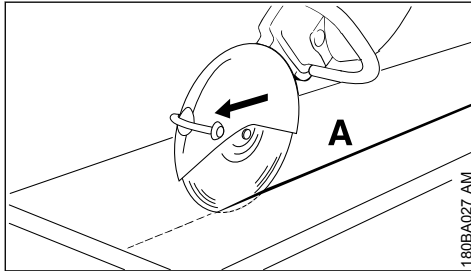

- ▶ Work along the cutting line. When making corrections, do not tilt the abrasive wheel, but always set the abrasive wheel against the workpiece anew – the cutting depth for each operation should not exceed 5 to 6 cm. Cut thicker material in multiple operations

### 3.5 Cutting plates

- ▶ Secure the plate (e. g. on a non-slip surface, sandbed)

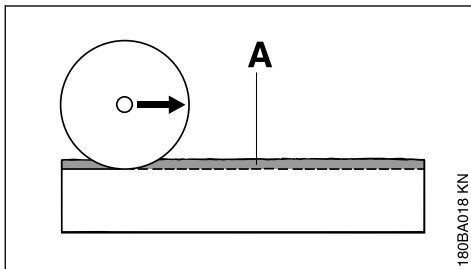

- ▶ Grind a guide groove (A) along the line marked

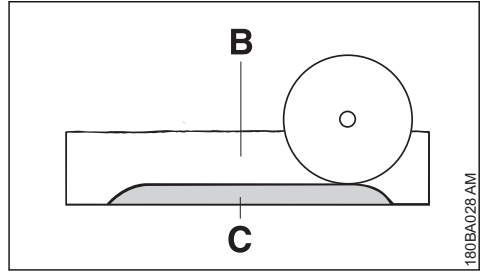

- ▶ Make the cut (B) deeper
- ▶ Leave a "hinge" (C)
- ▶ First sever the plate at the cut ends so that no material breaks away
- ▶ Break plate

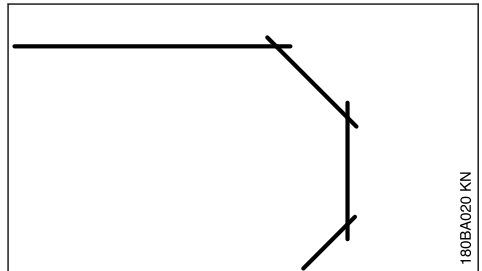

- ▶ Make curves in multiple operations – make certain that the abrasive wheel does not tilt

### 3.6 Cutting pipes, round and hollow bodies

- ▶ Secure pipes, round and hollow bodies against vibrations, slipping and rolling away
- ▶ Note direction of fall and weight of the severed part
- ▶ Determine and mark the cutting line, avoid reinforcement, especially in the direction of the severing cut
- ▶ Determine sequence of severing cuts
- ▶ Grind a guide groove along the line marked
- ▶ Make cut deeper along the guide groove – observe the recommended cutting depth for each operation – for small corrections of direction, do not tilt the abrasive wheel, but always position it anew instead – if necessary, leave small ridges that hold the part that is to be separated in position. Break these ridges after the last planned cut

### 3.7 Cutting concrete pipe

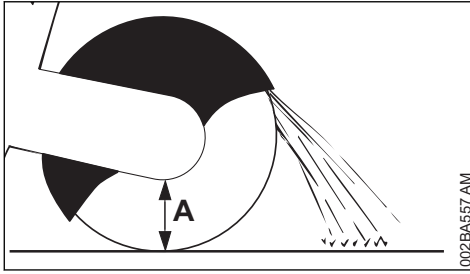

002BA557 AM

The procedure is dependent on the outer diameter of the pipe and the maximum possible cutting depth of the abrasive wheel (A).

- ▶ Secure pipe against vibrations, slipping and rolling away
- ▶ Note weight, tension and direction of fall of the part to be severed

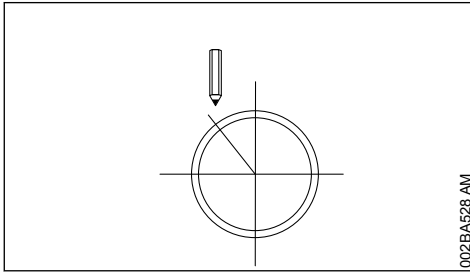

002BA528 AM

- ▶ Determine and mark direction of cut
- ▶ Determine sequence of cuts

**Outer diameter is smaller than the maximum cutting depth**

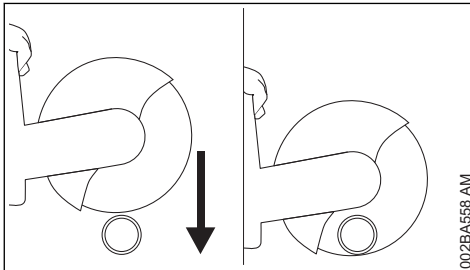

002BA558 AM

- ▶ Make **one** cut from the top to the bottom

**Outer diameter is greater than the maximum cutting depth**

Plan first, then cut. **Several** cuts are needed – correct sequence is important.

- ▶ Turn guard at rear stop

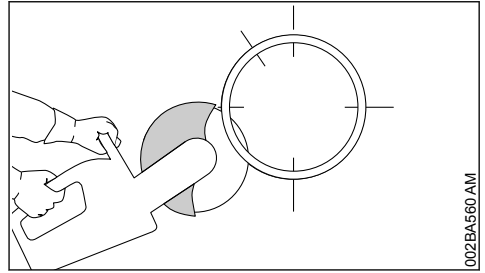

002BA560 AM

- ▶ Always start at the bottom, use the upper quarter of the abrasive wheel for cutting

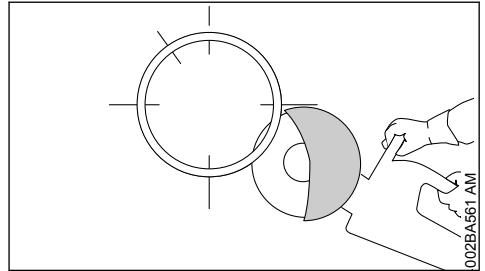

002BA561 AM

- ▶ Use the upper quarter of the abrasive wheel for cutting the opposite lower side.

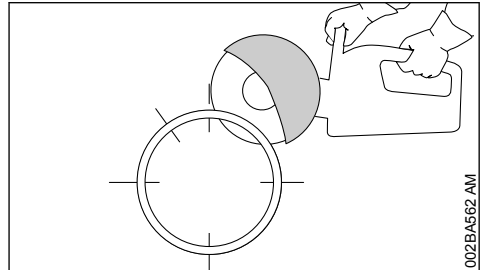

002BA562 AM

- ▶ First lateral cut on the top half of the pipe

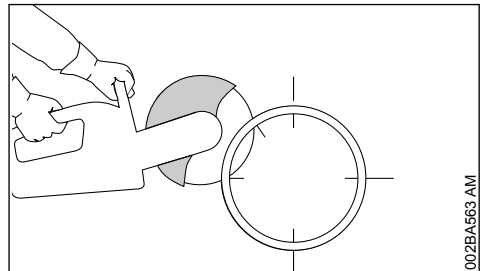

002BA563 AM

- ▶ Second lateral cut in the marked area – never cut into the area of the last cut, to ensure a firm hold on the part of pipe to be cut

Only make the last top cut once all bottom and lateral cuts have been made.

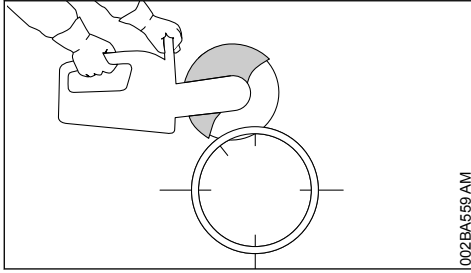

002BA559 AM

- ▶ Last cut always from the top (approx. 15 % of the pipe circumference)

### 3.8 Concrete pipe – cut recess

Sequence of cuts (1 to 4) is important:

- ▶ First, cut hard-to-reach areas

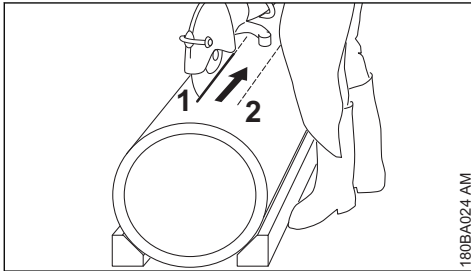

180BA024 AM

- ▶ Always make severing cuts so that the abrasive wheel is not pinched

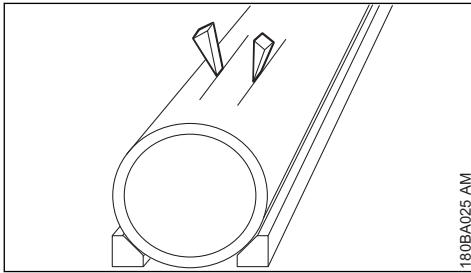

180BA025 AM

- ▶ Use wedges and/or leave ridges that are broken after cutting

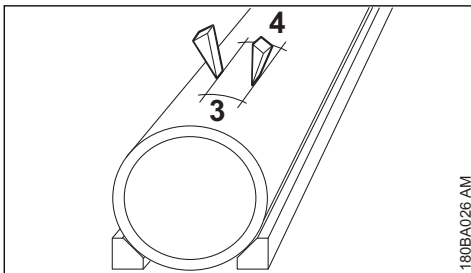

180BA026 AM

- ▶ If the severed part remains in the recess after cutting (due to wedges, ridges used), do not make any further cuts – break the severed part

## 4 Cutting Wheels

Abrasive wheels are exposed to extremely high loads especially during freehand cutting.

Therefore only for use of approved and correspondingly labeled abrasive wheels with hand-held machines as per EN 13236 (diamond) or EN 12413 (composite resin). Note maximum permissible speed of the abrasive wheel – **risk of accident!**

The abrasive wheels, which have been developed by STIHL in cooperation with renowned manufacturers of abrasive wheels, are of high quality and tailored precisely to the respective intended use as well as the engine performance of the cut-off machine.

They are of consistently outstanding quality.

### 4.1 Transport and storage

- Do not expose abrasive wheels to direct sunshine or other thermal stresses during transport and storage
- Avoid jolting and impacts
- Stack abrasive wheels flat on a level surface in the original packaging in a dry place where the temperature is as constant as possible
- Do not store abrasive wheels in the vicinity of aggressive fluids
- Store abrasive wheels in a frost-free place

## 5 Composite Abrasive Wheels

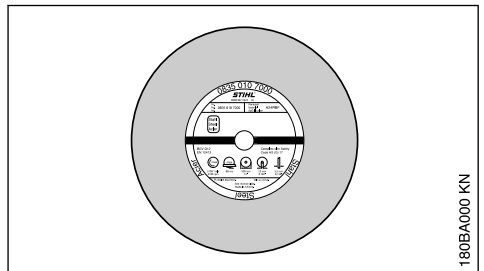

180BA000 KN

Types:

- for dry applications
- for wet applications

The proper selection and use of composite resin cutting wheels ensures economical use and

avoids accelerated wear. The product code which appears

- on the label and
- on the packaging (table with recommendations for use) is an aid to selection

STIHL composite resin cutting wheels are suitable, depending on the version, for cutting the following materials:

- Asphalt
- Concrete
- Stone
- Ductile cast iron pipes
- Steel; STIHL composite resin cutting wheels are not suitable for cutting railway tracks

Do not cut any other materials – **risk of accident!**

## 6 Diamond Abrasive Wheels

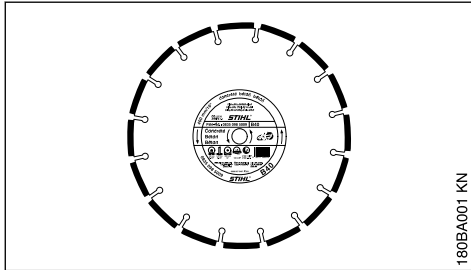

For wet applications.

The proper selection and use of diamond abrasive wheels ensures economical use and avoids accelerated wear. The product code which appears

- on the label and
- on the packaging (table with recommendations for use) is an aid to selection

STIHL diamond abrasive wheels are suitable, depending on the version, for cutting the following materials:

- Asphalt
- Concrete
- Stone (hard stone)
- Abrasive concrete
- Fresh concrete
- Clay brick
- Clay pipe
- Ductile cast iron pipe

Do not cut any other materials – **Risk of accident!**

Never use diamond abrasive wheels with side plating as they jam in the cut and can result in extreme kickback – **Risk of accident!**

### 6.1 Product Codes

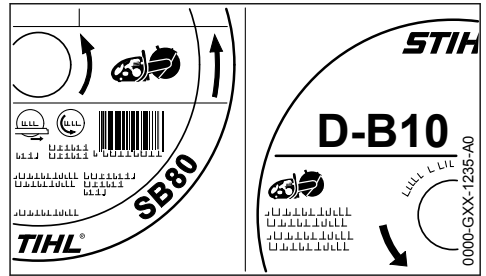

The product code is a combination of letters and numbers, consisting of up to four characters:

- the letters denote the main field of application of the abrasive wheel
- the numbers denote the performance class of the STIHL diamond abrasive wheel

### 6.2 Axial and radial run-out

A faultless spindle bearing of the cut-off machine is necessary for a long service life and efficient functioning of the diamond abrasive wheel.

Using the abrasive wheel on a cut-off machine with a faulty spindle bearing can lead to deviations in radial and axial run-out.

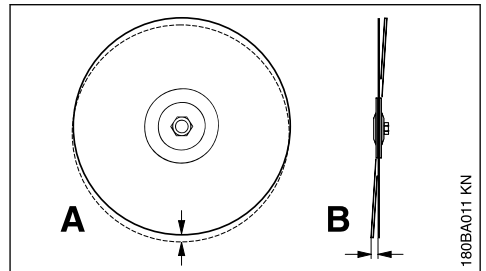

An excessively high radial run-out deviation (A) overloads individual diamond segments, which overheat in the process. This can lead to stress cracks in the parent wheel or to annealing of individual segments.

Deviations in axial run-out (B) result in higher thermal loading and wider cuts.

### 6.3 Undercut

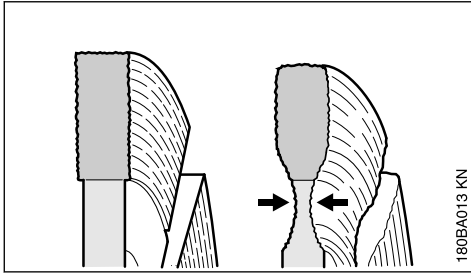

Do not cut into the base course (frequently chipped stones and gravel) when cutting roadway pavement – cutting in chipped stones and gravel is revealed by light-colored dust – excessive undercut may occur as a result – **Danger of shattering!**

### 6.4 Built-up edges, sharpen

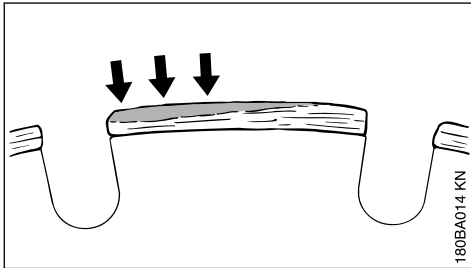

Built-up edges take the form of a light gray deposit on the tops of the diamond segments. This deposit on the segments clogs the diamonds and blunts the segments.

## 6.5 Troubleshooting

### 6.5.1 Abrasive wheel

| Defects                                                                              | Cause                                                                 | Remedy                                                                                   |
|--------------------------------------------------------------------------------------|-----------------------------------------------------------------------|------------------------------------------------------------------------------------------|
| ragged edges or cut surfaces, crooked cut<br>heavy wear on the sides of the segments | Deviation in radial or axial run-out<br>Abrasive wheel gyrates        | Contact a servicing dealer <sup>1)</sup><br>use a new abrasive wheel                     |
| ragged edges, crooked cut, no cutting performance, generation of sparks              | Abrasive wheel is dull; built-up edges with abrasive wheels for stone | Sharpen abrasive wheels for stone by briefly cutting through abrasive materials; replace |

Built-up edges can form:

- when cutting extremely hard materials, e. g., granite
- with incorrect handling, e. g., excessive feed effort

Built-up edges increase vibration, reduce cutting performance, and cause formation of sparks.

At the first signs of built-up edges, immediately "sharpen" the diamond abrasive wheel – to do this, briefly cut through abrasive material such as sandstone, aerated concrete or asphalt.

Addition of water prevents the formation of built-up edges.

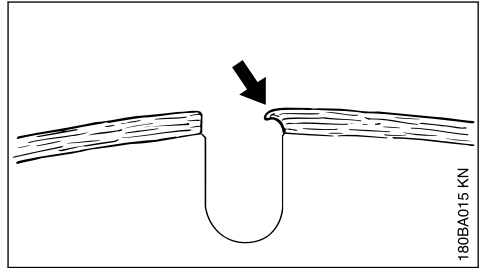

If work continues with dull segments, these may soften due to the high heat generated – the parent wheel is annealed and its strength is compromised – this can lead to stresses that are clearly recognizable by gyrations of the abrasive wheel. Do not continue to use the abrasive wheel – **Risk of accident!**

<sup>1)</sup> STIHL recommends STIHL servicing dealers

| Defects                                             | Cause                                            | Remedy                                                                 |
|-----------------------------------------------------|--------------------------------------------------|------------------------------------------------------------------------|
|                                                     |                                                  | abrasive wheel for asphalt with a new one                              |
| poor cutting performance, high segment wear         | Abrasive wheel is turning in the wrong direction | Mount abrasive wheel so that it turns in the right direction           |
| Breakdowns or tears in the parent wheel and segment | Overloading                                      | use a new abrasive wheel                                               |
| Undercut                                            | Cutting in the wrong material                    | use new abrasive wheel; observe separating layers of various materials |

## 7 Electronic Water Control

STIHL cut-off machines may be equipped with an electronic water control system.

The electronic water control makes it possible to feed the optimum amount of water to the abrasive wheel. No water is fed to the abrasive wheel during idling.

### 7.1 Before starting work

- Familiarize yourself with the sequence of motions while the engine is switched off

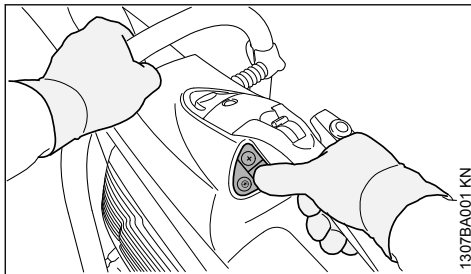

- All of the control panel buttons can be operated with the thumb of the right hand – the right hand always remains on the rear handle while doing so
- The left hand always remains on the handlebar

### 7.2 Control panel

When the engine is running, it is possible to activate / deactivate the electronic water control and adjust the water flow.

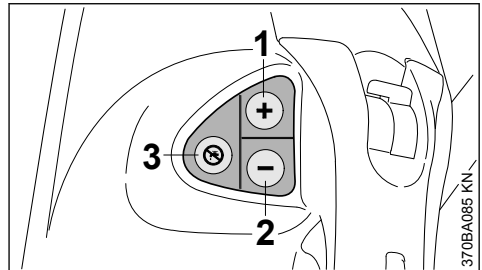

- 1 Button (+):**  
activate the electronic water control or increase water flow to abrasive wheel
- 2 Button (-):**  
activate the electronic water control or decrease water flow to abrasive wheel
- 3 Deactivate electronic water control; no water is fed to the abrasive wheel**

### 7.3 Using the electronic water control

- Start engine, see "Starting / Stopping the Engine"
- Tap on the (+) button or (-) button with the thumb of the right hand – the right hand always remains on the rear handle while doing so, the left hand always remains on the handlebar – no water is fed to the abrasive wheel yet during idling

During use, the set amount of water is fed to the abrasive wheel.

- Adjust water flow if necessary – to do so, tap on the (+) button or (-) button with the thumb of the right hand until the correct water quantity is attained – the right hand always remains on the rear handle while doing so, the left hand always remains on the handlebar

If the cut-off machine is idling after use, no more water will be fed to the abrasive wheel – the elec-

<sup>1)</sup> STIHL recommends STIHL servicing dealers



tronic water control, however, remains activated. With continued use, the last quantity of water set will be fed to the abrasive wheel again automatically.

If the engine is stopped and restarted, the electronic water control is switched off.

### 7.3.1 For installation on the STIHL FW 20 cut-off machine cart

If the cut-off machine is mounted on the STIHL FW 20 cut-off machine cart in combination with the water tank, feed the maximum amount of water.

## 7.4 Maintenance and care

If too little water or no water is fed to the abrasive wheel during use although the electronic water control has been activated:

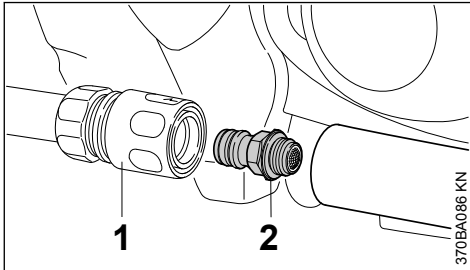

- ▶ Remove the coupling sleeve (1)
- ▶ Unscrew "water connection with screen" (2) and rinse under running water – the screen remains on the water connection

If too little water or no water is fed to the abrasive wheel although the screen has been cleaned, visit your servicing dealer.

## 8 Assembling the cast arm and guard

The "cast arm with guard" is mounted on the inboard side by the manufacturer.

The "cast arm with guard" can also be mounted on the outboard side depending on requirements.

Assembly on the inboard side is recommended for freehand cutting on account of the better balance.

### 8.1 Outboard mounting

- ▶ Disassemble the abrasive wheel (see "Fitting / replacing an abrasive wheel")

### 8.1.1 Removing the water attachment

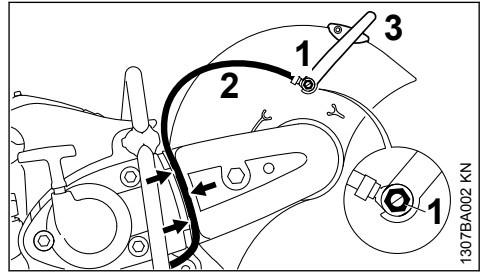

- ▶ Unscrew the banjo bolt (1) with the combination wrench – in the process, remove the square nut from the inside of the guard from the guide
- ▶ Remove the water hose (2) with connector from the adjusting lever (3)
- ▶ Pull the water hose (2) out of the guide (arrows) in the V-belt guard

### 8.1.2 Removing the adjusting lever

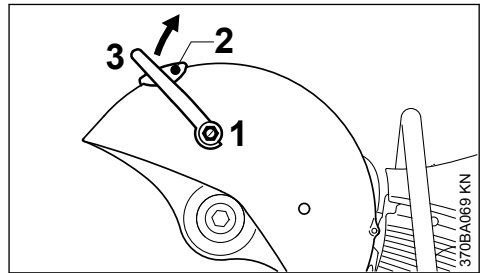

- ▶ Unscrew the banjo bolt (1) with the combination wrench and remove it together with the seal – in the process, remove the square nut from the inside of the guard from the guide
- ▶ Unscrew the screw (2)
- ▶ Turn the adjusting lever (3) upwards and remove

### 8.1.3 Slackening the V-belt

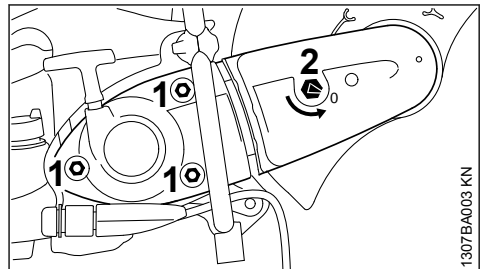

- ▶ Unscrew the nuts (1) – do not remove them

- ▶ Turn the tensioning nut (2) counterclockwise with the combination wrench – approx. 1/4 turn, as far as it will go = 0

**8.1.4 Removing the V-belt guard**

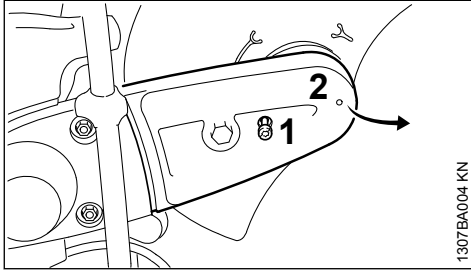

- ▶ Unscrew the screw (1) – screw (1) is secured on the V-belt guard (2) to prevent loss
- ▶ Raise the V-belt guard (2) slightly and pull it off to the front

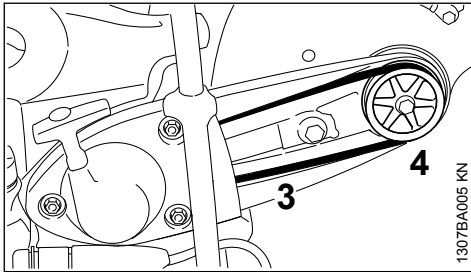

- ▶ Remove the V-belt (3) from the front pulley (4)

**8.1.5 Removing the "cast arm with guard"**

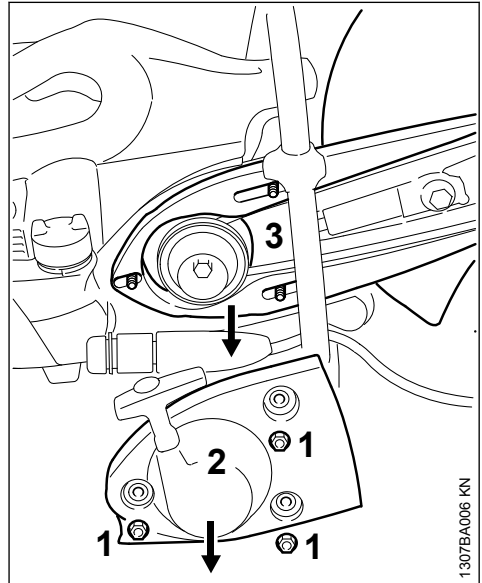

- ▶ Remove the nuts (1)
- ▶ Remove the "starter cover with rewind starter" (2)
- ▶ Remove the "cast arm with guard" (3) from the studs

**8.1.6 Preparing the "cast arm with guard" for outboard mounting**

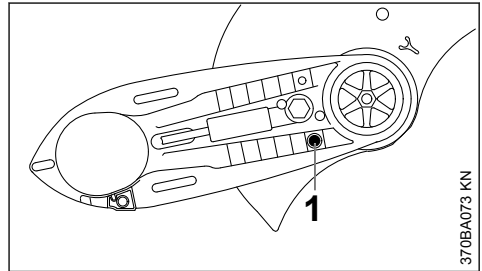

- ▶ Unscrew the stop pin (1)

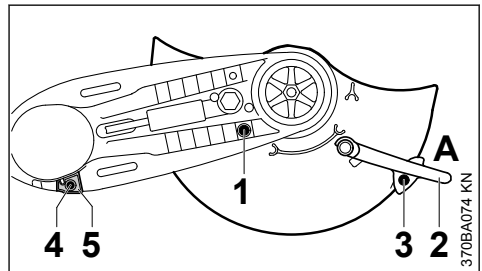

- ▶ Turn the guard so that it is in the position shown (see picture)
- ▶ Screw in and tighten the stop pin (1)
- ▶ Move the adjusting lever (2) to position A
- ▶ Screw in the bolt (3) and tighten up
- ▶ Remove screw (4) from the limit stop (5)
- ▶ Pull off the limit stop (5)

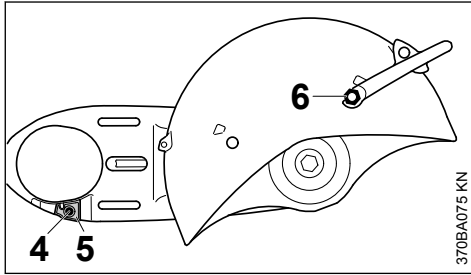

- ▶ Turn the "cast arm with guard" so that the guard is on the outboard side
- ▶ Insert limit stop (5) – align the hole in the limit stop with the hole in the cast arm
- ▶ Screw in the bolt (4) and tighten up
- ▶ Insert the square nut into the guide in the guard and hold it in place
- ▶ Screw in the shorter banjo bolt (6) and washer at the adjusting lever and tighten up with the combination wrench

### 8.1.7 Mounting "cast arm with guard" – guard on the outboard side

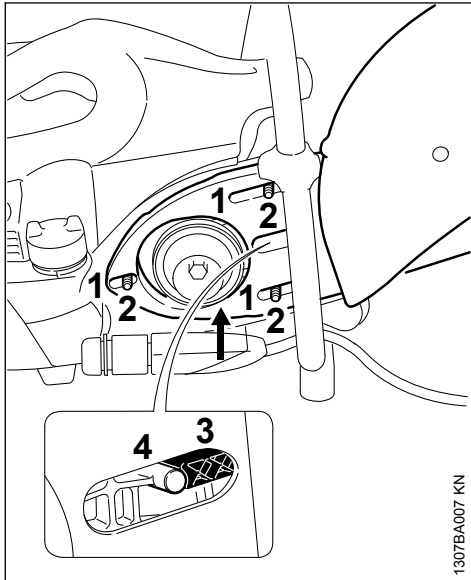

- ▶ Press the oblong holes (1) in the "cast arm and guard" on to the studs (2), guiding the ribbed V-belt over the front pulley

#### NOTICE

The belt action must run smoothly.

- ▶ The belt tensioner (3) must sit close to the lug (4)

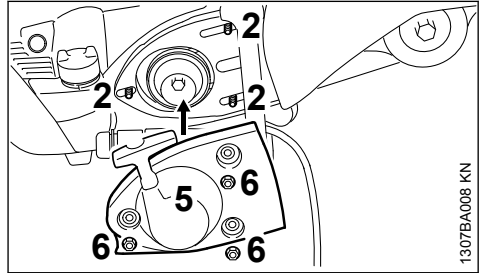

- ▶ Fit the "starter cover with rewind starter" (9) over the studs (2)
- ▶ Tighten up the nuts (6) by hand

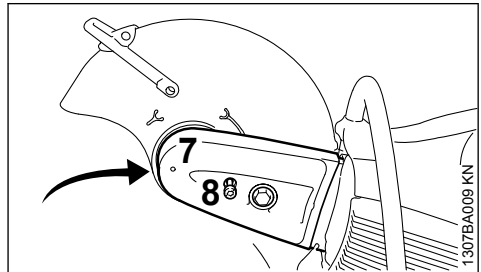

- ▶ Push the V-belt guard (7) into place
- ▶ Screw in the bolt (8) and tighten up

### 8.1.8 Connecting the water connection

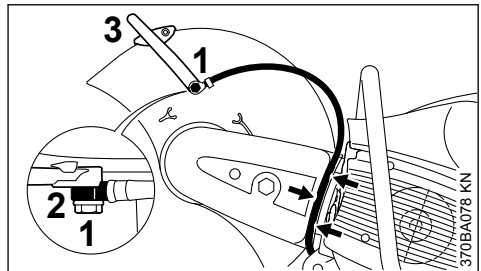

- ▶ Insert the longer banjo bolt (1) through the connector (2) of the water attachment – observe the position of the connector
- ▶ Insert the square nut into the guide in the guard and hold it in place

- ▶ Fit the support with the longer banjo bolt on the adjusting lever (3) – screw in the banjo bolt and tighten with the combination wrench
- ▶ Insert the water hose into the guide in the V-belt guard (arrow) from the water connection towards the guard – avoid tight radiuses

### 8.1.9 Checking the adjustment range of the guard

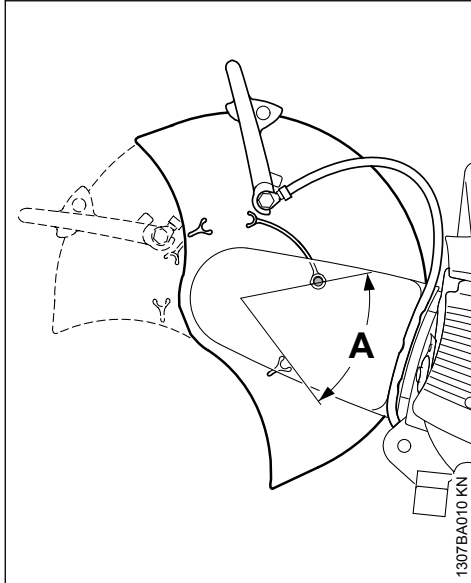

- ▶ Rotate the guard forwards and backwards as far as possible – adjustment range (A) must be limited by the stop pin

Continue as described in the chapter “Tensioning the V-belt”.

## 8.2 Inboard mounting

- ▶ Disassemble the abrasive wheel (see “Fitting / replacing an abrasive wheel”)
- ▶ Remove the water attachment
- ▶ Remove the adjusting lever
- ▶ Slacken the V-belt
- ▶ Remove the V-belt guard
- ▶ Remove the “cast arm with guard”

### 8.2.1 Preparing the “cast arm with guard” for inboard mounting

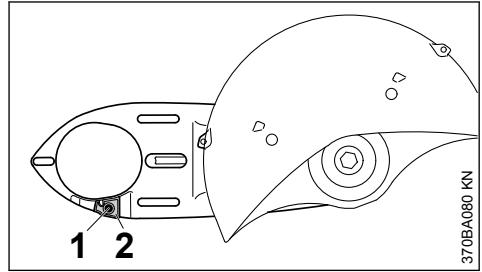

- ▶ Remove screw (1) from the limit stop (2)
- ▶ Pull off the limit stop (2)

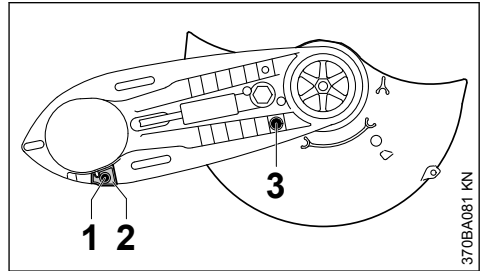

- ▶ Turn the “cast arm with guard” so that the guard is on the inboard side
- ▶ Insert limit stop (2) – align the hole in the limit stop with the hole in the cast arm
- ▶ Screw in the bolt (1) and tighten up
- ▶ Remove the nuts (3)

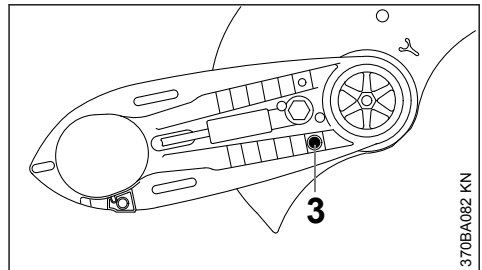

- ▶ Turn the guard so that it is in the position shown (see picture)
- ▶ Screw in and tighten the stop pin (3)
- ▶ Install the adjusting lever
- ▶ Mount “cast arm with guard” – guard on the inboard side
- ▶ Install the V-belt guard
- ▶ Connect water connection

### 8.2.2 Checking the adjustment range of the guard

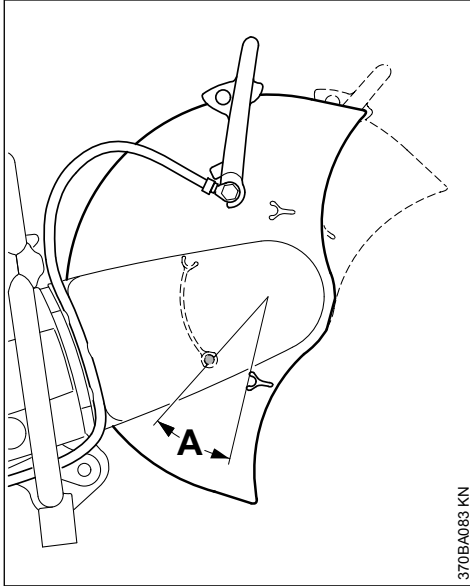

- ▶ Rotate the guard forwards and backwards as far as possible – adjustment range (A) must be limited by the stop pin

Continue as described in the chapter “Tensioning the V-belt”.

## 9 Tensioning the ribbed V-belt

This machine is equipped with an automatic spring-action V-belt tensioning device.

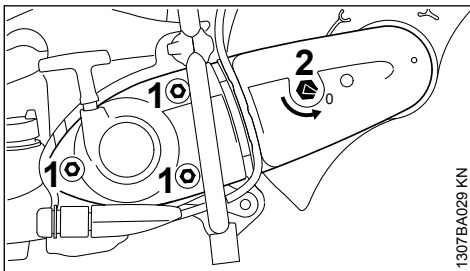

Prior to tensioning of the ribbed V-belt, the nuts (1) must be loosened and the arrow on the tensioning nut (2) must point to 0.

- ▶ otherwise loosen the nuts (1) and the tensioning nut (2) with the combination wrench counterclockwise – approx. 1/4 turn, as far as possible = 0

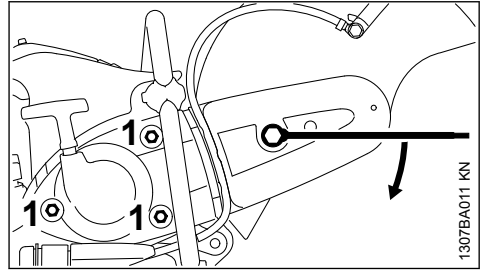

- ▶ to tighten the ribbed V-belt, fit the combination wrench over the tensioning nut as illustrated

### ! WARNING

The tensioning nut is spring-loaded – hold the combination wrench securely.

- ▶ Turn the tensioning nut clockwise approx. 1/8 turn – the tensioning nut will be engaged by the spring
- ▶ Continue turning approx. 1/8 turn – up to the stop

### NOTICE

Do not turn the combination wrench further by force.

The V-belt is automatically tensioned by the force of the spring in this position.

- ▶ Remove the combination wrench from the tensioning nut
- ▶ Tighten up the nuts (1)

### 9.1 Retensioning the V-belt

The V-belt is retensioned without the aid of the tensioning nut.

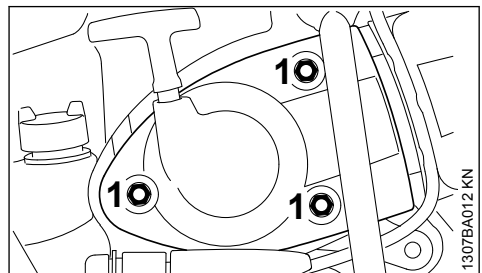

- ▶ Loosen the nuts (1) – V-belt is retensioned automatically by the force of the spring
- ▶ Tighten up the nuts (1) again

## 10 Mounting an Abrasive Wheel

The engine must be switched off for fitting or replacement – move stop switch to **STOP** or **0**.

### 10.1 Blocking the shaft

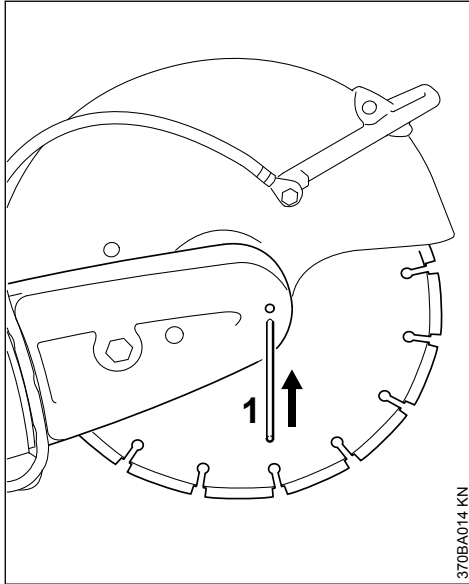

370BA014 KN

- ▶ Slide the locking pin (1) through the bore in the V-belt guard
- ▶ Turn the shaft with the combination wrench until the locking pin (1) engages in the bore behind the guard

### 10.2 Removing an abrasive wheel

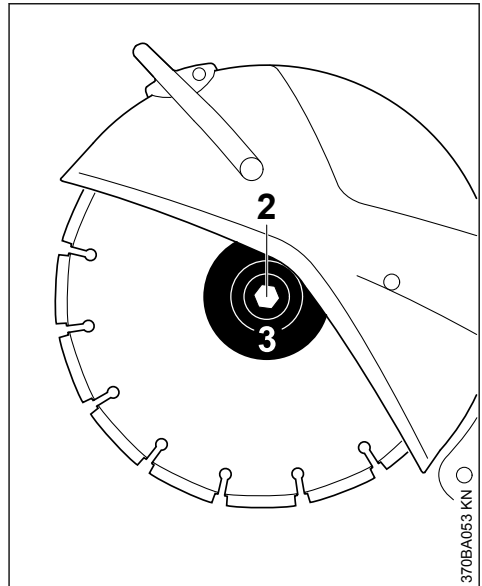

370BA053 KN

- ▶ Use the combination wrench to loosen and remove the hexagon head screw (2)
- ▶ Remove the front thrust washer (3) from the shaft together with the abrasive wheel

### 10.3 Fitting an abrasive wheel

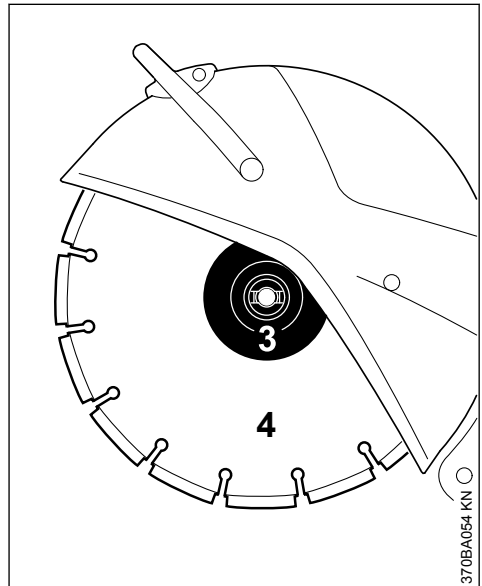

370BA054 KN

- ▶ Fit the new abrasive wheel (4)

 **WARNING**

Note the arrows indicating the direction of rotation on diamond abrasive wheels.

- ▶ Fit the front thrust washer (3). The catches of the front thrust washer (3) must engage in the shaft grooves
- ▶ Screw in the hexagon bolt and **tighten it** with the combination wrench – if using a torque wrench, refer to the "Specifications" for the tightening torque
- ▶ Draw the locking pin out of the V-belt guard

 **WARNING**

Never use two abrasive wheels at the same time. The uneven wear creates a **risk of breaking and an injury hazard!**

## 11 Fuel

The engine requires a mixture of gasoline and engine oil.

 **WARNING**

Avoid direct skin contact with fuel and breathing in of gasoline fumes.

### 11.1 STIHL MotoMix

STIHL recommends using STIHL MotoMix. This pre-blended fuel is free of benzene and lead, is distinguished by a high octane rating, and always provides the proper mixing ratio.

STIHL MotoMix is blended with STIHL HP Ultra two-stroke engine oil for maximum engine life.

MotoMix is not available in all markets.

### 11.2 Mixing fuel

#### NOTICE

Unsuitable fuels or a mixing ratio that deviates from the specification can lead to severe engine damage. The engine, seals, fuel lines and fuel tank may be damaged if low-quality gasoline or engine oil is used.

#### 11.2.1 Gasoline

Use only **high-quality gasoline** with an octane rating of at least 90 ROC – leaded or unleaded.

Engines with M-Tronic or STIHL Injection deliver full engine performance using gasoline with an alcohol component of up to 27% (E27).

#### 11.2.2 Engine oil

If you mix the fuel yourself, use only STIHL two-stroke engine oil or another high-performance engine oil classified as JASO FB, JASO FC, JASO FD, ISO-L-EGB, ISO-L-EGC or ISO-L-EGD.

STIHL specifies STIHL HP Ultra two-stroke engine oil or an equivalent high-performance engine oil in order to maintain emission limits over the machine's service life.

#### 11.2.3 Mixing ratio

with STIHL two-stroke engine oil 1:50; 1:50 = 1 part oil + 50 parts gasoline

#### 11.2.4 Examples

| Quantity of gaso-<br>line | STIHL two-stroke<br>engine oil 1:50 |
|---------------------------|-------------------------------------|
| Liters                    | Liters (ml)                         |
| 1                         | 0.02 (20)                           |
| 5                         | 0.10 (100)                          |
| 10                        | 0.20 (200)                          |
| 15                        | 0.30 (300)                          |
| 20                        | 0.40 (400)                          |
| 25                        | 0.50 (500)                          |

- ▶ Pour oil into an approved safety fuel canister first, then add gasoline and mix thoroughly

### 11.3 Storing fuel mixture

Store in approved safety fuel canisters only in a dry, cool and secure place protected against light and sunlight.

**Fuel mixture deteriorates with age** – mix only as much as needed for a few weeks. Do not store fuel mixture for longer than 30 days. The fuel mixture can become unusable more quickly if exposed to light, sunlight or low or high temperatures.

STIHL MotoMix however can be stored for up to 5 years without any problems.

- ▶ Shake the canister containing the fuel mixture thoroughly before refueling

 **WARNING**

Pressure may have built up in the canister – open it carefully.

- ▶ The fuel tank and the canister in which fuel mixture is stored should be cleaned thoroughly from time to time

Residual fuel and the liquid used for cleaning must be disposed of properly in accordance with environmental regulations!

## 12 Fueling



### 12.1 Preparing the machine

- ▶ Before fueling, clean the filler cap and the area around it so that dirt cannot fall into the tank
- ▶ Always position the machine so that the filler cap is facing upwards



**WARNING**

Never use a tool to open the bayonet filler cap. The cap can be damaged and fuel may escape.

### 12.2 Opening the filler cap

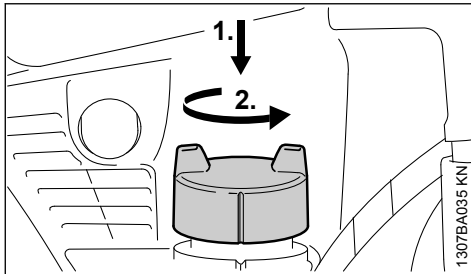

- ▶ Press the filler cap down as far as possible by hand, then turn it counterclockwise (approx. 1/8 turn) and remove

### 12.3 Refueling

Take care not to spill fuel while fueling and do not overfill the tank. STIHL recommends use of the STIHL filling system for fuel (special accessory).

### 12.4 Closing the filler cap

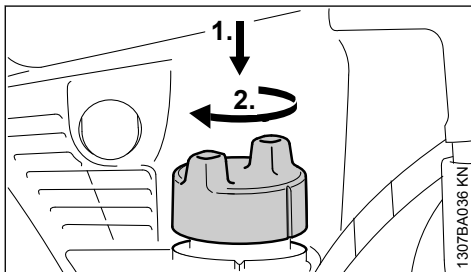

- ▶ Fit the cap and turn it until it engages in the bayonet catch
- ▶ Press the cap down as far as possible by hand and turn it clockwise (approx. 1/8 turn) until it engages

### 12.5 Checking the lock

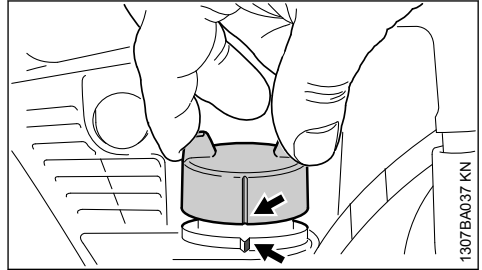

- ▶ Grip the cap – the cap is closed properly if it cannot be removed and the markings (arrows) on the cap and fuel tank are aligned

If the cap can be removed or the markings do not align, close the cap again – see sections "Closing the filler cap" and "Checking the lock".

### 12.6 Changing the fuel pickup body every year

The fuel pickup body is equipped with a magnetic separator.

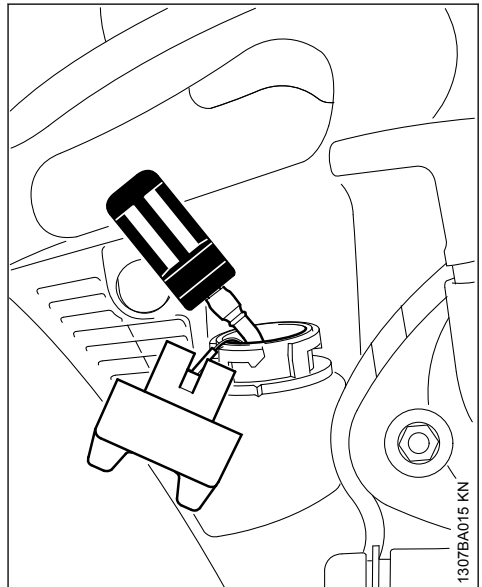

- ▶ Drain the fuel tank



- ▶ Pull the fuel pickup body out of the tank with a hook and disconnect it from the hose
- ▶ Connect a new fuel pickup body to the hose
- ▶ Return the fuel pickup body to the tank

## 13 Starting / Stopping the Engine

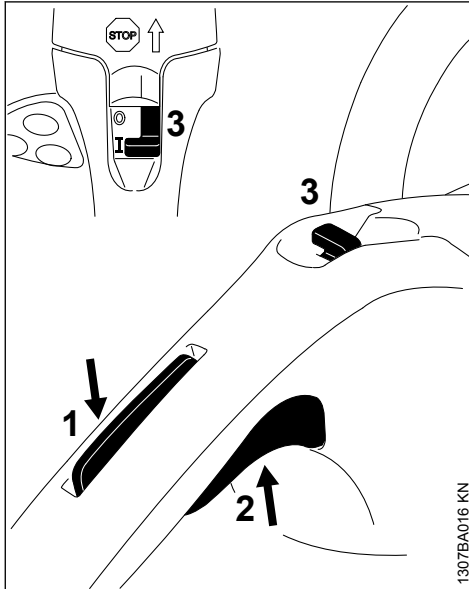

- ▶ Press throttle trigger lockout (1) and then press throttle trigger (2)
- ▶ Hold both triggers down
- ▶ Set the stop switch (3) to I
- ▶ Release the throttle trigger, stop switch and throttle trigger lockout in succession – **starting throttle position**

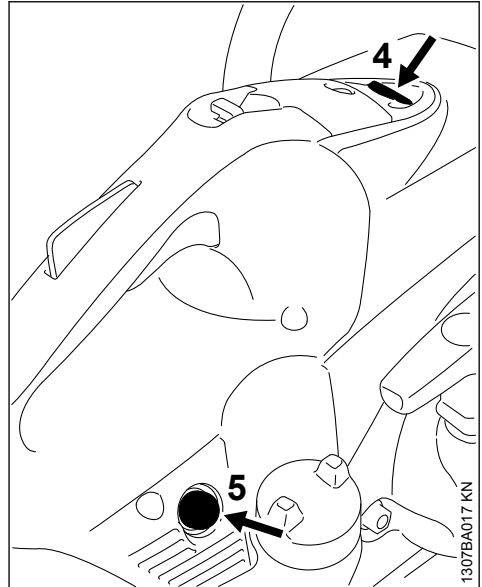

- ▶ Press the button (4) of the decompression valve
- ▶ Press the manual fuel pump bulb (5) 7-10 times, even when the bulb is filled with fuel

### 13.1 Starting

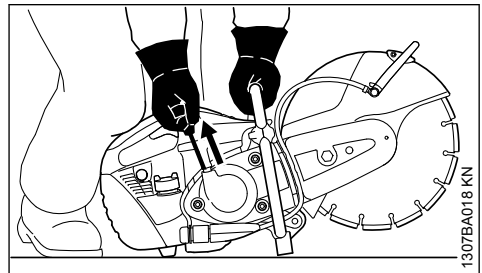

- ▶ Place the cut-off machine carefully on the ground, ensuring that the abrasive wheel cannot touch the ground or any objects. There must not be anyone within the swivel range of the cut-off machine
- ▶ Make sure you have a firm footing
- ▶ Press the cut-off machine firmly against the ground, holding the handle with your left hand, thumb wrapped round the handle
- ▶ Press the cut-off machine against the ground with the right knee on the shroud

- ▶ Pull the starter grip slowly with your right hand until you feel it engage – then give it a brisk strong pull – do not pull out the starter rope all the way

### NOTICE

Do not let the starter grip snap back – it may **break!** Guide it back into the housing in the opposite direction so that it can rewind properly.

## 13.2 Once the engine is running

- ▶ Let the engine run for a few seconds - important: the abrasive wheel may begin to rotate!
- ▶ Blip the throttle trigger and throttle trigger lock-out so that the engine settles down to idle speed

The cut-off machine is now ready for use.

### ! WARNING

The abrasive wheel must not rotate when the engine is idling. Have the machine repaired by a STIHL servicing dealer if the abrasive wheel turns while the engine is idling. STIHL recommends STIHL servicing dealers.

## 13.3 Switching off the engine

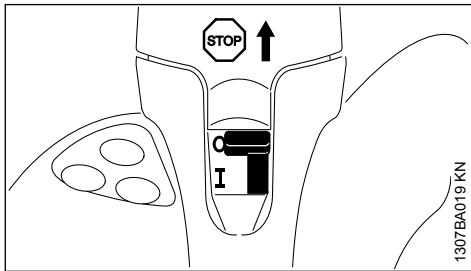

- ▶ Move stop switch to **STOP** or **0**

## 13.4 Additional hints on starting

### 13.4.1 If the tank has been drained completely

- ▶ Refueling
- ▶ Press the manual fuel pump bulb 7-10 times – even if it is full of fuel
- ▶ Restart the engine

### 13.4.2 At very low temperatures or if the machine is extremely cold

- ▶ Allow the engine to warm up longer after starting – important: the abrasive wheel may begin to rotate!

- ▶ Blip the throttle trigger and throttle trigger lock-out so that the engine settles down to idle speed

## 14 Air Filter System

### 14.1 Basic information

The average filter life is more than 1 year. Do not dismantle the filter cover or fit a new air filter unless there is a noticeable loss of engine power.

In the long-life air filter system with the cyclone pre-separation system, dirty air is drawn in and deliberately rotated. The larger and heavier particles carried in the air are thus expelled and extracted. Only pre-cleaned air enters the air filter system and the result is extremely long filter life.

### 14.2 Replacing the air filter

#### 14.2.1 Only if there is a noticeable loss of engine power

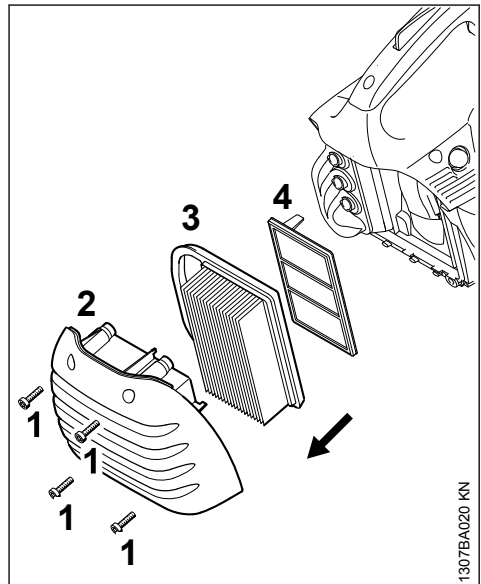

- ▶ Undo the screws (1)
- ▶ Remove the filter cover (2) and clean it
- ▶ Remove the main filter (3)
- ▶ Remove the auxiliary filter (4) – ensuring that dirt does not enter the intake area
- ▶ Clean the filter area
- ▶ Insert new auxiliary filter (4) and new main filter (3)
- ▶ Refit filter cover (2)

► Retighten screws (1)

Only high-quality air filters should be used, to protect the engine against ingress of abrasive dust.

STIHL recommends the use of genuine STIHL air filters. The high quality of these parts will ensure trouble free operation, a long service life for the engine and extremely long filter life.

## 15 STIHL Injection

STIHL Injection regulates the fuel quantity and ignition timing for all operating states electronically.

STIHL Injection stands for easy, fast starting, constant optimum engine performance, outstanding acceleration and automatic adaptation to changes in operating conditions.

## 16 Spark Plug

- If the engine is down on power, difficult to start or runs poorly at idle speed, first check the spark plug.
- Fit a new spark plug after about 100 operating hours – or sooner if the electrodes are badly eroded. Install only suppressed spark plugs of the type approved by STIHL – see "Specifications".

### 16.1 Removing the spark plug

- Switch off the engine – move stop switch to **STOP** or **0**

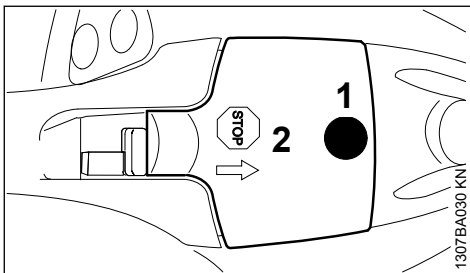

- Unscrew screw (1) and remove cap (2) – screw (1) is secured in the cap (2) to prevent loss

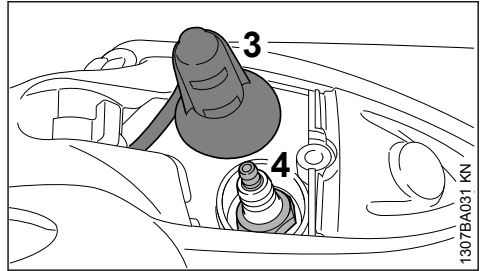

- Remove the spark plug boot (3).
- Unscrew the spark plug (4).

### 16.2 Checking the Spark Plug

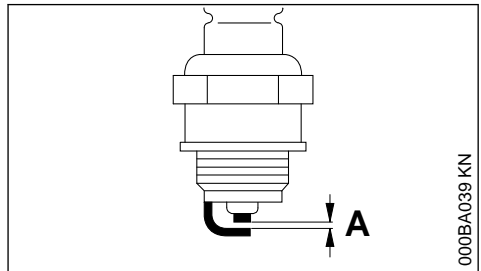

- Clean dirty spark plug.
- Check electrode gap (A) and readjust if necessary – see "Specifications".
- Rectify the problems which have caused fouling of the spark plug.

Possible causes are:

- Too much oil in fuel mix.
- Dirty air filter.
- Unfavorable running conditions.

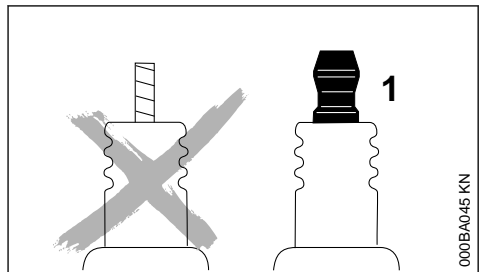

## ! WARNING

Arcing may occur if the adapter nut (1) is loose or missing. Working in an easily combustible or explosive atmosphere may cause a fire or an explosion. This can result result in serious injuries or damage to property.

- ▶ Use resistor type spark plugs with a properly tightened adapter nut.

### 16.3 Installing the spark plug

- ▶ Fit the spark plug by hand and screw it in
- ▶ Tighten spark plug with combination wrench
- ▶ Press the spark plug boot firmly onto the spark plug
- ▶ Position the cap for the spark plug boot and screw it down

## 17 Replacing the V-belt

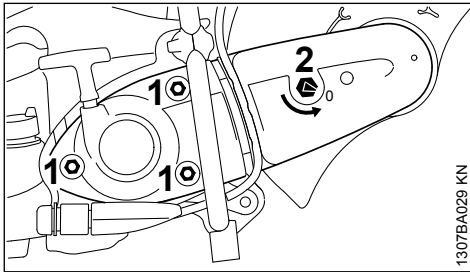

- ▶ Undo the nuts (1)
- ▶ Turn the tensioning nut (2) counterclockwise with the combination wrench – approx. 1/4 turn, as far as it will go = 0

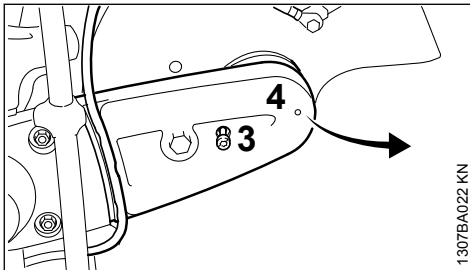

- ▶ Pull the water hose out of the guide in the V-belt guard
- ▶ Unscrew the screw (3)
- ▶ Raise the V-belt guard (4) slightly and pull it off to the front

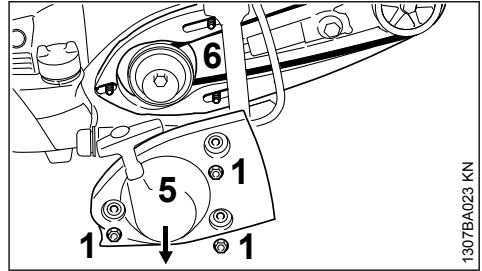

- ▶ Remove the V-belt from the front pulley
- ▶ Remove the nuts (1)
- ▶ Remove the starter cover (5)
- ▶ Do not remove the "cast arm and guard" (6) – hold it in place on the studs until the starter cover is fitted back in position
- ▶ Remove the defective V-belt

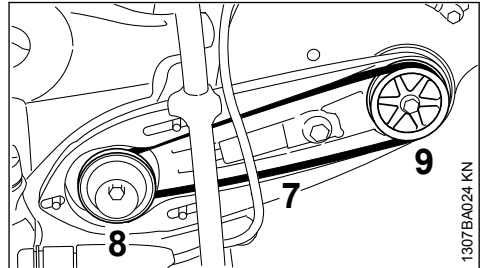

- ▶ Carefully insert the new V-belt (7) on the V-belt pulley (8) on the engine and the front V-belt pulley (9)

### NOTICE

The belt action must run smoothly.

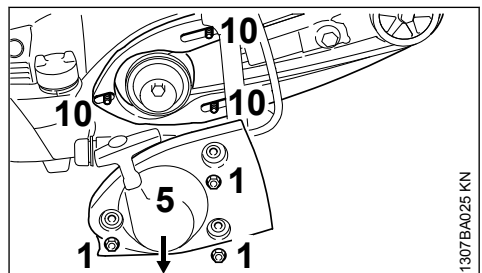

- ▶ Fit the starter cover (5) over the studs (10)
- ▶ Tighten up the nuts (1) by hand

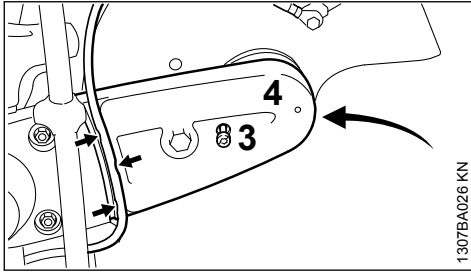

- ▶ Push the V-belt guard (4) into place
- ▶ Screw in the bolt (3) and tighten up
- ▶ Insert the water hose into the guide in the V-belt guard (arrows) from the water connection towards the guard – avoid tight radiuses

Continue as described in the chapter “Tensioning the V-belt”.

## 18 Cut-off Machine Cart

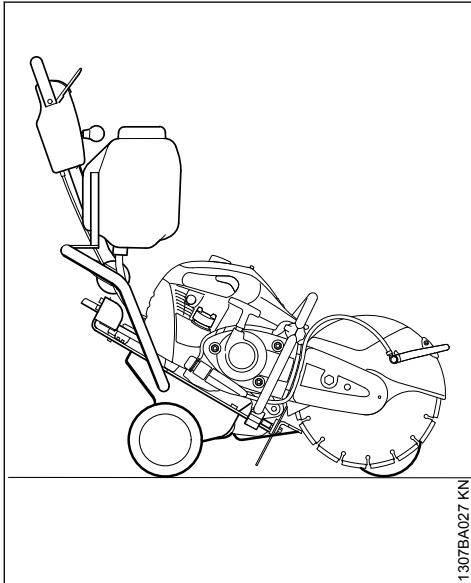

The cut-off machine can be mounted on the STIHL cut-off machine cart FW 20 (special accessory) in a few easy steps.

The cut-off machine cart makes it easier to

- repair damaged roadways
- apply roadway markings
- cut expansion joints

## 19 Storing the Machine

- If not used for periods of about 30 days or longer
- ▶ Drain and clean the fuel tank in a well-ventilated area.
  - ▶ Dispose of fuel properly in accordance with environmental regulations
  - ▶ Remove the cutting wheel
  - ▶ Thoroughly clean the machine
  - ▶ Store the machine in a dry and secure location. Keep out of the reach of children and other unauthorized persons

## 20 Maintenance and Care

| The information applies to normal operating conditions. The specified intervals must be shortened accordingly when working for longer than normal or under difficult cutting conditions (extensive dust, etc.). |                                                                | Before starting work                                      | At the end of work and/or daily | Whenever tank is refilled | Weekly | Monthly | Yearly | If faulty | If damaged | As required |
|-----------------------------------------------------------------------------------------------------------------------------------------------------------------------------------------------------------------|----------------------------------------------------------------|-----------------------------------------------------------|---------------------------------|---------------------------|--------|---------|--------|-----------|------------|-------------|
|                                                                                                                                                                                                                 |                                                                |                                                           |                                 |                           |        |         |        |           |            |             |
| Complete machine                                                                                                                                                                                                | Visual inspection (condition, leaks)                           | X                                                         |                                 | X                         |        |         |        |           |            |             |
|                                                                                                                                                                                                                 | Clean                                                          |                                                           | X                               |                           |        |         |        |           |            |             |
| Controls                                                                                                                                                                                                        | Check operation                                                | X                                                         |                                 | X                         |        |         |        |           |            |             |
| Manual fuel pump (if present)                                                                                                                                                                                   | Inspect                                                        | X                                                         |                                 |                           |        |         |        |           |            |             |
|                                                                                                                                                                                                                 | Have them repaired by a specialist dealer <sup>1)</sup>        |                                                           |                                 |                           |        |         |        |           | X          |             |
| Fuel pickup body in fuel tank                                                                                                                                                                                   | Inspect                                                        |                                                           |                                 |                           |        |         |        | X         |            |             |
|                                                                                                                                                                                                                 | Replace                                                        |                                                           |                                 |                           |        |         | X      |           | X          | X           |
| Fuel tank                                                                                                                                                                                                       | Clean                                                          |                                                           |                                 |                           |        | X       |        |           |            |             |
| V belt                                                                                                                                                                                                          | Clean/re-tension                                               |                                                           |                                 |                           |        | X       |        |           |            | X           |
|                                                                                                                                                                                                                 | Replace                                                        |                                                           |                                 |                           |        |         |        |           | X          | X           |
| Air filter (all filter components)                                                                                                                                                                              | Replace                                                        | <b>Only if there is a noticeable loss of engine power</b> |                                 |                           |        |         |        |           |            |             |
| Cooling air intake slits                                                                                                                                                                                        | Clean                                                          |                                                           | X                               |                           |        |         |        |           |            |             |
| Cylinder fins                                                                                                                                                                                                   | Have them cleaned by a specialist dealer <sup>1)</sup>         |                                                           |                                 |                           |        |         | X      |           |            |             |
| Electronic water control                                                                                                                                                                                        | Inspect                                                        | x                                                         |                                 |                           |        |         |        | x         |            |             |
|                                                                                                                                                                                                                 | repair by authorized dealer <sup>1)</sup>                      |                                                           |                                 |                           |        |         |        |           | x          |             |
| STIHL Injection                                                                                                                                                                                                 | Check idle adjustment – abrasive cutting wheel must not rotate | X                                                         |                                 | X                         |        |         |        |           |            |             |
|                                                                                                                                                                                                                 | repair by authorized dealer <sup>1)</sup>                      |                                                           |                                 |                           |        |         |        | X         |            | X           |
| Spark plug                                                                                                                                                                                                      | Adjust electrode gap                                           |                                                           |                                 |                           |        |         |        | X         |            |             |
|                                                                                                                                                                                                                 | Replace after 100 hours' operation                             |                                                           |                                 |                           |        |         |        |           |            |             |
| All accessible screws, nuts and bolts                                                                                                                                                                           | Tighten                                                        |                                                           | X                               |                           |        |         |        |           |            | X           |
| Antivibration elements                                                                                                                                                                                          | Inspect                                                        | X                                                         |                                 |                           |        |         |        | X         |            | X           |
|                                                                                                                                                                                                                 | Have them replaced by a servicing dealer <sup>1)</sup>         |                                                           |                                 |                           |        |         |        |           | X          |             |
| Abrasive cutting wheel                                                                                                                                                                                          | Inspect                                                        | X                                                         |                                 | X                         |        |         |        |           |            |             |
|                                                                                                                                                                                                                 | Replace                                                        |                                                           |                                 |                           |        |         |        |           | X          | X           |

<sup>1)</sup> STIHL recommends the STIHL servicing dealer

|                                                                                                                                                                                                                        |         |                                 |   |  |  |  |   |   |  |
|------------------------------------------------------------------------------------------------------------------------------------------------------------------------------------------------------------------------|---------|---------------------------------|---|--|--|--|---|---|--|
| <p>The information applies to normal operating conditions. The specified intervals must be shortened accordingly when working for longer than normal or under difficult cutting conditions (extensive dust, etc.).</p> |         | Before starting work            |   |  |  |  |   |   |  |
|                                                                                                                                                                                                                        |         | At the end of work and/or daily | X |  |  |  |   |   |  |
|                                                                                                                                                                                                                        |         | Whenever tank is refilled       |   |  |  |  |   |   |  |
|                                                                                                                                                                                                                        |         | Weekly                          |   |  |  |  |   |   |  |
|                                                                                                                                                                                                                        |         | Monthly                         |   |  |  |  |   |   |  |
|                                                                                                                                                                                                                        |         | Yearly                          |   |  |  |  |   |   |  |
|                                                                                                                                                                                                                        |         | If faulty                       |   |  |  |  |   |   |  |
|                                                                                                                                                                                                                        |         | If damaged                      |   |  |  |  | X | X |  |
|                                                                                                                                                                                                                        |         | As required                     |   |  |  |  |   |   |  |
| Supports/rubber buffers (underneath the machine)                                                                                                                                                                       | Inspect |                                 |   |  |  |  |   |   |  |
|                                                                                                                                                                                                                        | Replace |                                 |   |  |  |  | X | X |  |
| Safety information label                                                                                                                                                                                               | Replace |                                 |   |  |  |  | X |   |  |

## 21 Minimize Wear and Avoid Damage

Compliance with the specifications of this Instruction Manual will avoid excessive wear and damage to the machine.

The machine must be used, maintained and stored as carefully as described in this Instruction Manual.

The user is responsible for all damage caused by failure to comply with the safety, operating and maintenance instructions. This applies in particular for:

- Product modifications not authorized by STIHL
- Use of tools or accessories that are not approved for the machine, unsuitable or of inferior quality
- Use of the machine in a manner not in keeping with the intended use
- Use of the machine in sporting events or competitions
- Consequential damages due to continued use of a machine with defective components

### 21.1 Maintenance work

All of the tasks listed under "Maintenance and Care" must be carried out periodically. If the user does not carry out these maintenance tasks him- or herself, they should be delegated to a dealer.

STIHL recommends that maintenance and repair work be carried out only by authorized STIHL dealers. STIHL dealers receive regular training and are supplied with technical information.

If these tasks are not performed or are performed improperly, this may result in damage for

which the user is responsible. These include, among others:

- Engine damage due to delayed or insufficient maintenance (e. g., air and fuel filters) or insufficient cleaning of the cooling air routing (air intake slits, cylinder fins)
- Corrosion damage and other consequential damages due to improper storage
- Damage to the machine as a result of using replacement parts of inferior quality

### 21.2 Wear parts

Some parts of the machine are subject to normal wear and tear even when the machine is used in conformity with its intended use. These parts must be replaced in due time, depending on the nature and duration of use. These include, among others:

- Clutch, V-belt
- Abrasive wheels (all types)
- Filters (air, fuel)
- Rewind starter
- Spark plug
- Components of anti-vibration system

<sup>1)</sup> STIHL recommends the STIHL servicing dealer

## 22 Main Parts

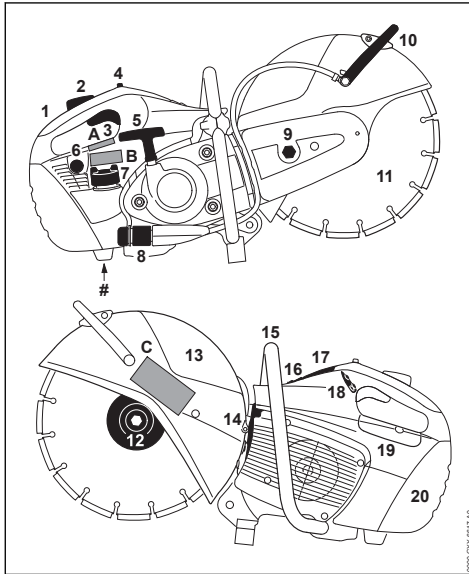

- 1 Rear handle
- 2 Throttle trigger lockout
- 3 Throttle trigger
- 4 Stop switch
- 5 Starter grip
- 6 Manual fuel pump
- 7 Filler cap
- 8 Water connection
- 9 Tensioning nut
- 10 Adjusting lever
- 11 Abrasive cutting wheel
- 12 Front thrust washer
- 13 Deflector
- 14 Muffler
- 15 Handlebar
- 16 Decompression valve
- 17 Cap for spark plug boot
- 18 Control panel water control
- 19 Cover for service
- 20 Filter cover
- # Machine number
- A Safety information label
- B Safety information label

## C Safety information label

## 23 Specifications

### 23.1 STIHL Injection

Control unit with characteristic-curve-driven ignition timing adjustment

load-dependent, characteristic-curve-driven fuel injection

### 23.2 Electronic water control

The electronic water control allows the optimum water quantity to be supplied to the abrasive cutting wheel. No water is supplied when the tool is idling.

### 23.3 Engine

STIHL single-cylinder two-stroke engine

#### 23.3.1 TS 480i

|                                                  |                               |
|--------------------------------------------------|-------------------------------|
| Displacement:                                    | 72.2cm <sup>3</sup>           |
| Cylinder bore:                                   | 52 mm                         |
| Piston stroke:                                   | 34 mm                         |
| Engine power to ISO 7293:                        | 3.9 kW (5.3 hp) at 9300 1/min |
| Idle speed:                                      | 2500 rpm                      |
| Max. spindle speed in accordance with ISO 19432: | 4985 rpm                      |

#### 23.3.2 TS 500i

|                                                  |                               |
|--------------------------------------------------|-------------------------------|
| Displacement:                                    | 72.2cm <sup>3</sup>           |
| Cylinder bore:                                   | 52 mm                         |
| Piston stroke:                                   | 34 mm                         |
| Engine power to ISO 7293:                        | 3.9 kW (5.3 hp) at 9300 1/min |
| Idle speed:                                      | 2500 rpm                      |
| Max. spindle speed in accordance with ISO 19432: | 4780 rpm                      |

### 23.4 Spark plug, fuel tank capacity

|                          |                                                |
|--------------------------|------------------------------------------------|
| Spark plug (suppressed): | Bosch WSR 6 F<br>NGK BPMR 7 A<br>STIHL ZK C 14 |
| Electrode gap:           | 0.5 mm                                         |
| Fuel tank capacity:      | 725 cm <sup>3</sup> (0.725 l)                  |

### 23.5 Air filter

Main filter (paper filter) and flocked wire mesh auxiliary filter

### 23.6 Weight

without fuel, without abrasive cutting wheel, with electronic water control

|          |         |
|----------|---------|
| TS 480i: | 10.0 kg |
| TS 500i: | 10.2 kg |



## 23.7 Abrasive cutting wheels

The specified maximum permitted operating speed of the abrasive cutting wheel must be greater than or equal to the maximum spindle speed of the cut-off machine used.

## 23.8 Abrasive cutting wheels (TS 480i)

|                                 |        |
|---------------------------------|--------|
| Outside diameter:               | 300 mm |
| Max. thickness:                 | 3.5 mm |
| Hole diameter/spindle diameter: | 20 mm  |
| Tightening torque:              | 30 Nm  |

### Composite resin abrasive cutting wheels

|                                             |        |
|---------------------------------------------|--------|
| Minimum outside diameter of thrust washers: | 103 mm |
| Maximum cutting depth:                      | 100 mm |

### Diamond abrasive cutting wheels

|                                             |        |
|---------------------------------------------|--------|
| Minimum outside diameter of thrust washers: | 103 mm |
| Maximum cutting depth:                      | 100 mm |

## 23.9 Abrasive cutting wheels (TS 500i)

|                                 |        |
|---------------------------------|--------|
| Outside diameter:               | 350 mm |
| Max. thickness:                 | 4.5 mm |
| Hole diameter/spindle diameter: | 20 mm  |
| Tightening torque:              | 30 Nm  |

### Composite resin abrasive cutting wheels

|                                                           |        |
|-----------------------------------------------------------|--------|
| Minimum outside diameter of thrust washers: <sup>1)</sup> | 103 mm |
| Maximum cutting depth: <sup>2)</sup>                      | 125 mm |

<sup>1)</sup>For Japan, 118 mm

<sup>2)</sup>When using thrust washers with an outside diameter of 118 mm, the maximum cutting depth is reduced to 116 mm

### Diamond abrasive cutting wheels

|                                                           |        |
|-----------------------------------------------------------|--------|
| Minimum outside diameter of thrust washers: <sup>1)</sup> | 103 mm |
| Maximum cutting depth: <sup>2)</sup>                      | 125 mm |

<sup>1)</sup>For Japan, 118 mm

<sup>2)</sup>When using thrust washers with an outside diameter of 118 mm, the maximum cutting depth is reduced to 116 mm

## 23.10 Sound and Vibration Values

For further details on compliance with Vibration Directive 2002/44/EC, see

[www.stihl.com/vib](http://www.stihl.com/vib)

### 23.10.1 Sound pressure level $L_{peq}$ in accordance with ISO 19432

|          |          |
|----------|----------|
| TS 480i: | 98 dB(A) |
| TS 500i: | 98 dB(A) |

### 23.10.2 Sound power level $L_w$ in accordance with ISO 19432

|          |           |
|----------|-----------|
| TS 480i: | 112 dB(A) |
| TS 500i: | 112 dB(A) |

### 23.10.3 Vibration level $a_{hv,eq}$ to ISO 19432

|          | Handle, left:        | Handle, right:       |
|----------|----------------------|----------------------|
| TS 480i: | 2.2 m/s <sup>2</sup> | 2.2 m/s <sup>2</sup> |
| TS 500i: | 2.4 m/s <sup>2</sup> | 2.0 m/s <sup>2</sup> |

The K-factor in accordance with Directive 2006/42/EC is 2.0 dB(A) for the sound pressure level and sound power level; the K-factor in accordance with Directive 2006/42/EC is 2.0 m/s<sup>2</sup> for the vibration level.

## 23.11 REACH

REACH is an EC regulation and stands for the Registration, Evaluation, Authorization and Restriction of Chemical substances.

For information on compliance with the REACH regulation (EC) No. 1907/2006 see

[www.stihl.com/reach](http://www.stihl.com/reach)

## 23.12 Exhaust Emissions

The CO<sub>2</sub> value measured in the EU type approval procedure is specified at

[www.stihl.com/co2](http://www.stihl.com/co2)

in the product-specific technical data.

The measured CO<sub>2</sub> value was determined on a representative engine in accordance with a standardized test procedure under laboratory conditions and does not represent either an explicit or implied guarantee of the performance of a specific engine.

The applicable exhaust emission requirements are fulfilled by the intended usage and maintenance described in this User Manual. The operating license shall be void if the engine is modified in any way.

## 24 Maintenance and Repairs

Users of this machine may only carry out the maintenance and service work described in this user manual. All other repairs must be carried out by a servicing dealer.

STIHL recommends that you have servicing and repair work carried out exclusively by an authorized STIHL servicing dealer. STIHL dealers are regularly given the opportunity to attend training

courses and are supplied with the necessary technical information.

When repairing the machine, only use replacement parts which have been approved by STIHL for this power tool or are technically identical. Only use high-quality replacement parts in order to avoid the risk of accidents and damage to the machine.

STIHL recommends the use of original STIHL replacement parts.

Original STIHL parts can be identified by the STIHL part number, the **STIHL** logo and the STIHL parts symbol  (the symbol may appear alone on small parts).

## 25 Disposal

Contact the local authorities or your STIHL servicing dealer for information on disposal.

Improper disposal can be harmful to health and pollute the environment.

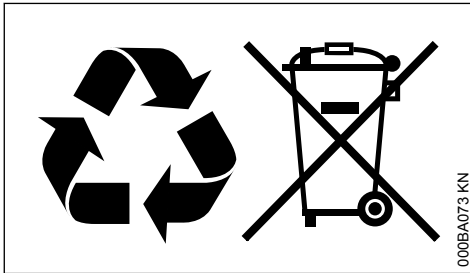

- ▶ Take STIHL products including packaging to a suitable collection point for recycling in accordance with local regulations.
- ▶ Do not dispose with domestic waste.

## 26 EC Declaration of Conformity

ANDREAS STIHL AG & Co. KG  
Badstr. 115  
D-71336 Waiblingen

Germany

declare under our sole responsibility that

|                               |                     |
|-------------------------------|---------------------|
| Designation:                  | Cut-off machine     |
| Make:                         | STIHL               |
| Series:                       | TS 480i             |
|                               | TS 500i             |
| Serial identification number: | 4250                |
| Displacement:                 | 72.2cm <sup>3</sup> |

conforms to the relevant provisions of Directives 2011/65/EU, 2006/42/EC, 2014/30/EU and

2000/14/EC and has been developed and manufactured in compliance with the following standards in the versions valid on the date of production:

EN ISO 19432, EN 55012, EN 61000-6-1

The measured and the guaranteed sound power level have been determined in accordance with Directive 2000/14/EC, Annex V, and standard ISO 3744.

### Measured sound power level

|          |           |
|----------|-----------|
| TS 480i: | 113 dB(A) |
| TS 500i: | 113 dB(A) |

### Guaranteed sound power level

|          |           |
|----------|-----------|
| TS 480i: | 115 dB(A) |
| TS 500i: | 115 dB(A) |

Technical documents deposited at:

ANDREAS STIHL AG & Co. KG  
Produktzulassung

The year of manufacture and serial number are applied to the product.

Done at Waiblingen, 15.07.2021

ANDREAS STIHL AG & Co. KG

pp



Dr. Jürgen Hoffmann

Director Product Certification & Regulatory Affairs



## 27 UKCA Declaration of Conformity

ANDREAS STIHL AG & Co. KG  
Badstr. 115  
D-71336 Waiblingen

Germany

declare under our sole responsibility that

|                               |                     |
|-------------------------------|---------------------|
| Designation:                  | Cut-off machine     |
| Make:                         | STIHL               |
| Series:                       | TS 480i             |
|                               | TS 500i             |
| Serial identification number: | 4250                |
| Displacement:                 | 72.2cm <sup>3</sup> |

conforms to the relevant provisions of UK regulations The Restriction of the Use of Certain Hazardous Substances in Electrical and Electronic Equipment Regulations 2012, Supply of Machinery (Safety) Regulations 2008, Electromagnetic Compatibility Regulations 2016 and Noise Emission in the Environment by Equipment for use Outdoors Regulations 2001 and has been manufactured in compliance with the following standards in the versions valid on the date of production:

EN ISO 19432, EN 55012, EN 61000-6-1

The measured and the guaranteed sound power level have been determined in accordance with UK regulation Noise Emission in the Environment by Equipment for use Outdoors Regulations 2001, Annex 8, using the ISO 3744 standard.

**Measured sound power level**

TS 480i: 113 dB(A)  
TS 500i: 113 dB(A)

**Guaranteed sound power level**

TS 480i: 115 dB(A)  
TS 500i: 115 dB(A)

Technical documents deposited at:

ANDREAS STIHL AG & Co. KG

The year of manufacture and serial number are indicated on the product.

Done at Waiblingen, 15.07.2021

ANDREAS STIHL AG & Co. KG

pp



Dr. Jürgen Hoffmann

Director Product Certification & Regulatory  
Affairs



[www.stihl.com](http://www.stihl.com)



0458-753-0121-D



0458-753-0121-D